



“America’s Most Responsive Warehouse”

Industrial Hose Coupling Catalog



featuring
EVER-TITE®



PRODUCT INDEX

90° Coupler with Check Valve	23	Hydrant Wrench.....	39
90° Cam & Groove Elbows.....	19, 23	Hydraulic Hose Couplings.....	45
A ir Hose, Red, Coupled.....	37	I DEAL Clamps.....	69-71
A.N.S.I. Class 150 Flange Couplings.....	22	Increases/ Reducers.....	14
APG Worm Gear Clamps.....	68	L ocking Handle Couplers.....	12-13
API Gravity Drop Coupler Replacement Gasket.....	22	Long Shank Hose Couplings.....	40
API Gravity Drop Couplings.....	22	M ale Stems- Collared & Band Style.....	44
Accessories for Cam and Groove Couplings.....	32-34	Menders.....	30
Adapter Caps.....	23	Military Specification Couplings.....	3
ASA Flange Couplings.....	22	N ipples, Combination.....	29-30
B all Valves.....	48-49	Nipples, Full Flow.....	67
BAND-IT® Products.....	59-67	No. 99 Elbow Couplings.....	20-21
Bleed-Off Couplers.....	12	Notched Collar Cam & Groove Couplings.....	29
Butt Weld Couplings.....	16	Nozzles, Hose.....	44
Cam and Groove Couplings.....	4-24, 29, 39	O verlocking Handles for Dust Caps.....	13
Check Valve, Swing w/Square Flange.....	24	P acking, Dome Manhole.....	25
Check Valve, w/ 90° Coupler.....	25	Pinlug Hose Shank Couplings.....	46
Check Valves, Swing.....	49	Positive-Locking Handle Couplers.....	12-13
Clamps, Double Bolt.....	57	Pressure Gauges.....	54-56
Clamps, Heavy Duty.....	57	Protective Sleaving.....	72-73
Clamps, High Pressure.....	57	Pull Handle Dust Plug.....	23
Clamps, IDEAL.....	69-71	Push-On Hose Barb Fittings.....	43
Clamps, Spiral.....	58	Q uick Disconnect Couplers and Plugs.....	50-51
Clamps, Universal.....	57	R ailroad Tank Car Adapter.....	22
Clamps, Worm Gear.....	68-71	Relief Nipple Cam & Groove Couplings.....	24
Combination Nipples.....	29-30	Reducers.....	14,30,39
Compression Gauge Cock.....	53	S afety Cables.....	32
Conbraco Water Gauges.....	52-53	Sand Blast Couplings.....	31
Coupler/Adapter with Relief Nipple.....	24	Short Shank Hose Couplings.....	41
Coupler/Adapters.....	15,24	Sleaving, Protective.....	72-73
Crimping Machines.....	27	Socket Weld Couplings.....	16-17
CrimpPro.....	26-29	Spanner Wrenches.....	46
Crimp Sleeves.....	28	Spiral Clamps.....	58
Crowfoot Couplings, Universal.....	36-37	Spool Adapter with Relief Nipple.....	24
D ouble-Locking Handle Couplers.....	12	Spool Adapters.....	15,24
Dust Plug w/ Pull Handle & Bump.....	22	Spool Couplers.....	15,19,24
E lbows, Cam & Groove.....	19-21, 23	Spool Coupler w/ Relief Nipple.....	24
EVER-TITE® Cam and Groove Couplings.....	4-24,29,39	Standard Hose Barb Fittings.....	42
EVER-TITE® Locking Handle Couplers.....	12	Strainers.....	35
F errules.....	28	Suction/ Pinlug Couplings.....	46
Fill-Pipe Adapters.....	23	Swing Check Valves.....	49
Fire Hose Couplings.....	39	Swivel-TITE® Couplers.....	29
Flanges.....	22,24-25	T ank Car Adapter, Railroad.....	22
Flange Couplings.....	22, 24	Tank Truck Flange Couplings.....	24
Foot Valves.....	35	Tight-Fill Couplings.....	20-21
G askets for Cam and Groove Couplings.....	18,33	Tough-TITE® Cam & Groove Couplings.....	4-24,29
Gaskets, Buna Fuel.....	33	Tough-TITE® Locking Handle Couplers.....	13
Gaskets, Pipe Coupling.....	34	U niversal Crowfoot Couplings.....	36
Gaskets, Sanitary.....	34	U-TITE® Cam and Groove Couplings.....	4-11
Gaskets, TTMA & Tank Truck.....	25	V alve, Ball.....	48-49
Gate Valves.....	49	Valve, Check.....	25
Gauge Cock, Compression.....	53	Valve, Foot.....	35
Gauges, Pressure.....	54-56	Valve, Gate.....	49
Gauges, Water.....	52-53	Valve, Swing Check.....	24,49
Gravity Drop Couplings.....	22	Vapor-Recovery System Parts.....	23
Ground Joint Couplings.....	47	W ater Gauges.....	52-53
H ammer Union Seals.....	34	Worm Gear Clamps.....	68-71
Handle Assemblies.....	32	Wrenches.....	39-46
Handwheels.....	23	Wrench, Spanner.....	46
Heavy Duty Couplings.....	18		
Hex Nipples.....	38		
Hose Barb Fittings.....	42-43		
Hose, Coupled Red Air.....	37		
Hose Nozzles.....	44		
Hose Shank Couplings, Pinlug.....	46		
Hydrant Adapters.....	38-39		



Our Policy

Prices

Prices quoted are for acceptance within thirty days from date quoted. Unless specified, prices are based on our receiving order for quantities quoted.

Terms

Our terms of payment are 1% 10, net 30 days, unless other arrangements are made through our credit department.

Minimum Invoice

Orders consisting of O-Rings Only - \$5.00

Orders consisting of O-Rings and/or All Other Products (Excluding Plastic Products) - \$15.00

City Sales Counter - \$35.00

Plastic Products - \$50.00

Line Minimum - \$1.00

Warranty

Products are warranted against defects in workmanship and defects in material. Products having such defects will be replaced or credited as APG elects. Defective items must be returned to APG for inspection unless advised otherwise. Liability is limited to the invoice value of the defective item. Our responsibility shall not exceed the original purchase price of the defective product. In any event, APG shall not be held responsible for any special or consequential damages sustained due to abuse, negligence, accident, misapplication or alteration. In all cases, please contact us for approval and routing of return items. **All claims of shortage or damage must be made within 30 days after receipt of shipment.** Customer will incur a restocking fee for items returned that are not warranted as described above. Obsolete material and non-standard materials fabricated on special orders may not be returned at all unless APG is at fault. Unless defective, returned goods must be in good condition and suitable for resale; otherwise, APG cannot issue any credit for the damaged parts.

Freight

All orders totaling less than \$1500 at NET prices are F.O.B. our warehouse with no freight allowance. Orders totaling \$1500 or more at NET prices, any product mix, receive full freight prepaid and allowed, provided such orders are for one shipment within the lower 48 continental United States and provided our normal freight modes are used. Special delivery charges incurred at the customer's request are for the customer's account. Exceptions to this freight prepaid and allowed policy: all glass products. These products are F.O.B. our warehouse with no freight allowance unless other items on the order total \$1500 or more at NET prices.

Catalog Information

Various information sources were used to compile this catalog. We offer this information only as a guide and cannot assume responsibility for accuracy of the data herein. Prices listed are current, subject to change.

Email:

Order's Submission: order@callapg.com

Quotes Requests: quote@callapg.com

Other Inquires: info@callapg.com

Phone:

Houston, TX: 800-888-5223

Knoxville, TN 800-382-8483

Grafton, OH: 800-883-7457

Santa Fe Springs, CA: 800-500-4222

Fax:

Houston, TX: 800-444-3252

Knoxville, TN: 800-471-6586

Grafton, OH: 440-926-1112

Contact Information:

APG
Most Responsive Service
Can be reached by
email, phone or fax

APG On-Line
Visit www.CALLAPG.com

Also available during
non-business hours is our
24/7 Call out Service.
Call 800-888-5223
for more information

Socialize with us @





Customization Solutions Across All Product Lines

APG's customizing capabilities can transform specifications into products to meet your job requirements. Also available is reverse engineering. From single quantity items to high volume productions, we have the ability and flexibility to meet your needs.

O-rings - APG can help you personalize your O-ring selections. Options include bagging, labeling, color coding, and creating kits.

Vulcanizing - APG Stocks over 200 variations of O-ring cord and over 100 variations of rubber sheet material ready to be vulcanized into the perfect seal (O-ring or sleeve) for the application it is designed for.

Gasket Fabrication - There are over 130 rubber and non-asbestos materials on the shelf that can be used to fabricate gaskets using the Water-jet, Flash Cutter, CAD/CAM, and Die-Cutting system. APG sheet materials are also used to create Custom Weather Stripping with or without two-sided adhesive.

Weld Fabrication – For processes requiring an alternative connection to complete an operation, APG can assist in producing Cam & Groove Quick Disconnect, Jump Size, Special Thread, Flanged, or Socket Weld and Butt Weld fittings.

Die-Cut Plastics – APG stocks a variety of plastic materials for specialized fabrication through our die-cutting process. In addition, APG stocks fabricated safety products that include replacement safety visors, sandblasting replacement lenses, blast cabinet underlayment, and S.C.B.A. cover lenses for industrial paintings and coating.

Machined Plastics – Collaborate with APG to produce a solution for applications requiring a special fit with one of our dedicated machines: HAAS VF-3 VMC Mill, (2) HAAS SL-30 CNC Lathes, HAAS SL-20 CNC Lathe. Advantages include low residual component stress, consistent properties throughout, and closer tolerances.

Industrial Glass – APG provides specialized glass products for demanding applications. This includes custom fabrication and lengths using Tubular & Flat Gauge Glass, Annular Edge Glass, Borosilicate and Vycor® Flat Glass, and Sight Glass. Also available are glass accessories.

Recommended maximum working pressures for Cam & Groove Couplings.

Material	Pressure Rating											
	1/2"	3/4"	1"	1-1/4"	1-1/2"	2"	2-1/2"	3"	4"	5"	6"	8"
Aluminum	250	250	250	250	250	250	150	125	100	75	75	50
Cast Brass	200	200	200	200	200	200	150	125	100	75	75	—
Forged Brass	350	350	350	350	350	350	250	250	100	—	—	—
Heavy Duty Cast Brass	300	300	300	300	300	225	200	200	—	—	—	—
Stainless Steel	250	250	250	250	250	250	200	200	100	75	75	—
Ductile Iron	—	—	—	—	125	125	—	100	100	—	—	—
Nylon	100	100	100	100	100	100	—	100	75	—	—	—
Polypropylene	100	100	100	100	100	100	—	100	75	—	—	—
Monel	250	250	250	250	250	250	200	200	150	75	75	—
Hastelloy C	250	250	250	250	250	250	200	200	150	75	75	—
Carpenter 20	250	250	250	250	250	250	200	200	150	75	75	—

Liability Warning: The proper selection and application of APG products is the end user and/or distributor's responsibility. APG has no warranty for loss that may occur due to a hose assembly not being properly selected or manufactured for the specific application. Cam and Groove Couplings are NOT designed for compressed gasses, compressed air, steam or propane applications.

“AMERICA’S MOST RESPONSIVE WAREHOUSE”



CALL US



EMAIL



FAX



WALK-IN

Anodizing

Anodizing

Anodizing is a process that adds a non-conductive layer to increase the durability, corrosion resistance and abrasion resistance of an aluminum fitting or sleeve. This protective layer increases the thickness of the alloy by .0004". Various colors are available to choose from. Another option is Hard Coat Aluminum which is an extended anodizing process. This protective layer increases the thickness of the alloy by .001".

EVER-TITE® Aluminum Cam and Groove Couplings can be ordered as compliant with military specifications by specifying anodized parts identified by military color number per MIL-A-8625.

EVER-TITE® Brass Cam and Groove Couplings are available as compliant with military specifications.

EVER-TITE® Aluminum and Brass Cam and Groove Couplings are compliant with Mil-C-27487 and A-A-59326.

MIL-C-27487 Military Standard Number - Summary Index												
Coupling Type	Item Code		Class	3/4	1	1-1/4	1-1/2	2	2-1/2	3	4	6
A	MS 27020	Aluminum	1	-3	-5	-7	-9	-11	-13	-15	-17	-19
		Brass	2	-4	-6	-8	-10	-12	-14	-16	-18	-20
B	MS 27026	Aluminum	1	-3	-5	-7	-9	-11	-13	-15	-17	-19
		Brass	2	-4	-6	-8	-10	-12	-14	-16	-18	-20
C	MS 27025	Aluminum	1	-3	-5	-7	-9	-11	-13	-15	-17	-19
		Brass	2	-4	-6	-8	-10	-12	-14	-16	-18	-20
D	MS 27024	Aluminum	1	-3	-5	-7	-9	-11	-13	-15	-17	-19
		Brass	2	-4	-6	-8	-10	-12	-14	-16	-18	-20
E	MS 27021	Aluminum	1	-3	-5	-7	-9	-11	-13	-15	-17	-19
		Brass	2	-4	-6	-8	-10	-12	-14	-16	-18	-20
F	MS 27022	Aluminum	1	-3	-5	-7	-9	-11	-13	-15	-17	-19
		Brass	2	-4	-6	-8	-10	-12	-14	-16	-18	-20
D.C.	MS 27028	Aluminum	1	-3	-5	-7	-9	-11	-13	-15	-17	-19
		Brass	2	-4	-6	-8	-10	-12	-14	-16	-18	-20
D.P.	MS 27029	Aluminum	1	-3	-5	-7	-9	-11	-13	-15	-17	-19
		Brass	2	-4	-6	-8	-10	-12	-14	-16	-18	-20
Gasket	MS 27030			-2	-3	-4	-5	-6	-7	-8	-9	-10

Note: Specify military color number per MIL-A-8625

Military Specification Compliance

Many different configurations of adapters and couplers are available. Female wyes with adapters/couplers and double female couplers with shut-off valve #77 are illustrated as representative of the configurations that are available. Please inquire regarding any specific requirement.





Cam and Groove Couplings

Part A Male Adapter x Female Thread

-NPT Standard



EVER-TITE® available options:

BSP, BST and NPSM thread
Monel, Hastelloy C and Carpenter 20® alloy
Anodizing (See page 2)

EVER-TITE®
Premium Cam and Groove Couplings

Size	Aluminum	Forged Brass	316 Stainless Steel	Polypropylene (black)
1/2"	305AAL	305ABR	305ASS	305APP
3/4"	307AAL	307ABR	307ASS	307APP
1"	310AAL	310ABR	310ASS	310APP
1-1/4"	312AAL	312ABR	312ASS	312APP
1-1/2"	315AAL	315ABR	315ASS	315APP
2"	320AAL	320ABR	320ASS	320APP
2-1/2"	325AAL	325ABR	325ASS	—
3"	330AAL	330ABR	330ASS	330APP
4"	340AAL	340ABR	340ASS	340APP
5"	350AAL	*350ARB	350ASS	—
6"	360AAL	*360ARB	360ASS	—
8"	380AAL	—	—	—

*Red Brass

EVER-TITE® and Tough-TITE® Note:

1/2" Aluminum, Brass and Stainless parts are not interchangeable

Tough-TITE®
Industrial Cam and Groove Couplings



Size	Aluminum	Brass	316 Stainless Steel	Ductile Iron	Nylon (yellow)	Polypropylene (black)
1/2"	3E05AAL	3E05ACB	3E05ASS	—	*3E05ANY	*3E05APP
3/4"	3E07AAL	3E07ACB	3E07ASS	—	3E07ANY	3E07APP
1"	3E10AAL	3E10ACB	3E10ASS	—	3E10ANY	3E10APP
1-1/4"	3E12AAL	3E12ACB	3E12ASS	—	**3E12ANY	**3E12APP
1-1/2"	3E15AAL	3E15ACB	3E15ASS	3E15ADI	3E15ANY	3E15APP
2"	3E20AAL	3E20ACB	3E20ASS	3E20ADI	3E20ANY	3E20APP
2-1/2"	3E25AAL	3E25ACB	3E25ASS	—	—	—
3"	3E30AAL	3E30ACB	3E30ASS	3E30ADI	3E30ANY	3E30APP
4"	3E40AAL	3E40ACB	3E40ASS	3E40ADI	3E40ANY	3E40APP
5"	3E50AAL	3E50ACB	—	—	—	—
6"	3E60AAL	3E60ACB	3E60ASS	—	—	—
8"	3E80AALA	—	3E80ASS	—	—	—

* 1/2" Nylon and Polypropylene adapter portion is to the 3/4" standard.

** 1-1/4" Nylon and Polypropylene adapter portion is to the 1-1/2" standard.

U-TITE®
Utility Cam and Groove Couplings



Size	Aluminum	Forged Brass	316 Stainless Steel
1/2"	3U05AAL	3U05AFB	3U05ASS
3/4"	3U07AAL	3U07AFB	3U07ASS
1"	3U10AAL	3U10AFB	3U10ASS
1-1/4"	3U12AAL	3U15AFB	3U12ASS
1-1/2"	3U15AAL	3U15AFB	3U15ASS
2"	3U20AAL	3U20AFB	3U20ASS
2-1/2"	3U25AAL	3U25AFB	3U25ASS
3"	3U30AAL	3U30AFB	3U30ASS
4"	3U40AAL	3U40AFB	3U40ASS
5"	3U50AAL	3U50AFB	3U50ASS
6"	3U60AAL	3U60AFB	3U60ASS

EVER-TITE® and U-TITE® Note:

1/2" Aluminum, Brass and Stainless parts are not interchangeable



Don't let week-end, holiday, or after-hours sales opportunities pass you by. APG has an emergency call-out service that has you covered. Just call the same number that you always call – any time – day or night.

Part B Female Coupler x Male Thread

EVER-TITE® Premium Cam and Groove Couplings

Size	Aluminum	Forged Brass	316 Stainless Steel	Polypropylene (black)
1/2"	305BAL	305BBR	305BSS	305BPP
3/4"	307BAL	307BBR	307BSS	307BPP
1"	310BAL	310BBR	310BSS	310BPP
1-1/4"	312BAL	312BBR	312BSS	312BPP
1-1/2"	315BAL	315BBR	315BSS	315BPP
2"	320BAL	320BBR	320BSS	320BPP
2-1/2"	325BAL	325BBR	325BSS	—
3"	330BAL	330BBR	330BSS	330BPP
4"	340BAL	340BBR	340BSS	340BPP
5"	350BAL	*350BRB	350BSS	—
6"	360BAL	*360BRB	360BSS	—
8"	380BAL	—	—	—

*Red Brass.

Investment Cast 316 Stainless Steel handles standard on EVER-TITE® Aluminum and Polypropylene couplers.

Brass handles standard on 8" Aluminum.

8" part has 4-handle design

EVER-TITE® and Tough-TITE® Note:

1/2" Aluminum, Brass and Stainless parts are not interchangeable

Tough-TITE® Industrial Cam and Groove Couplings

Size	Aluminum	Brass	316 Stainless Steel	Ductile Iron	Nylon (yellow)	Polypropylene (black)
1/2"	3E05BAL	3E05BCB	3E05BSS	—	*3E05BNY	*3E05BPP
3/4"	3E07BAL	3E07BCB	3E07BSS	—	3E07BNY	3E07BPP
1"	3E10BAL	3E10BCB	3E10BSS	—	3E10BNY	3E10BPP
1-1/4"	3E12BAL	3E12BCB	3E12BSS	—	**3E12BNY	**3E12BPP
1-1/2"	3E15BAL	3E15BCB	3E15BSS	3E15BDI	3E15BNY	3E15BPP
2"	3E20BAL	3E20BCB	3E20BSS	3E20BDI	3E20BNY	3E20BPP
2-1/2"	3E25BAL	3E25BCB	3E25BSS	—	—	—
3"	3E30BAL	3E30BCB	3E30BSS	3E30BDI	3E30BNY	3E30BPP
4"	3E40BAL	3E40BCB	3E40BSS	3E40BDI	3E40BNY	3E40BPP
5"	3E50BAL	3E50BCB	—	—	—	—
6"	3E60BAL	3E60BCB	3E60BSS	—	—	—

* 1/2" Nylon and Polypropylene coupler portion is to the 3/4" standard

** 1-1/4" Nylon and Polypropylene coupler portion is to the 1-1/2" standard.

Stainless Steel handles are standard on Tough-TITE® Polypropylene & Nylon couplers

Brass handles standard on Tough-Tite® Aluminum coupler

U-TITE® Utility Cam and Groove Couplings

Size	Aluminum	Forged Brass	316 Stainless Steel
1/2"	3U05BAL	3U05BFB	3U05BSS
3/4"	3U07BAL	3U07BFB	3U07BSS
1"	3U10BAL	3U10BFB	3U10BSS
1-1/4"	3U12BAL	3U12BFB	3U12BSS
1-1/2"	3U15BAL	3U15BFB	3U15BSS
2"	3U20BAL	3U20BFB	3U20BSS
2-1/2"	3U25BAL	3U25BFB	3U25BSS
3"	3U30BAL	3U30BFB	3U30BSS
4"	3U40BAL	3U40BFB	3U40BSS
5"	3U50BAL	3U50BFB	3U50BSS
6"	3U60BAL	3U60BFB	3U60BSS

Stainless Steel handles standard on U-TITE® Aluminum couplers

EVER-TITE® and U-TITE® Note:

1/2" Aluminum, Brass and Stainless parts are not interchangeable

-NPT Standard



EVER-TITE® available options:

Brass Handles, BSP and BST Thread, Monel, Hastelloy C and Carpenter 20® alloy Anodizing (See page 2)





Part C Female Coupler x Hose Shank

NEW PRODUCT

Shoulder now standard on 1-1/2", 2", 3" & 4" Ever-tite Aluminum Part C



EVER-TITE® available options:

- Brass handles
- Monel, Hastelloy C and Carpenter 20® alloy
- Anodizing (See page 2)

EVER-TITE® Premium Cam and Groove Couplings

Size	Aluminum	Forged Brass	316 Stainless Steel	Polypropylene (black)
1/2"	305CAL	305CBR	305CSS	305CPP
3/4"	307CAL	307CBR	307CSS	307CPP
1"	Δ310CAL	310CBR	310CSS	310CPP
1-1/4"	312CAL	312CRB	312CSS	312CPP
1-1/2"	Δ315CAL	315CBR	315CSS	315CPP
2"	Δ320CAL	320CBR	320CSS	320CPP
2-1/2"	Δ325CAL	325CRB	325CSS	—
3"	Δ330CAL	330CBR	330CSS	330CPP
4"	Δ340CAL	340CBR	340CSS	340CPP
5"	Δ350CAL	*350CRB	350CSS	—
6"	††Δ360CAL	*360CRB	360CSS	—
8"	380CAL	—	—	—

* Red Brass

Δ Machined shanks.

†† Available in 4-handle design (360CAL4)

Investment Cast 316 Stainless Steel handles standard on EVER-TITE® Aluminum and Polypropylene couplers.

EVER-TITE® and Tough-TITE® Note:

1/2" Aluminum, Brass and Stainless parts are not interchangeable

8" Aluminum part has 4-handle design

Tough-TITE® Industrial Cam and Groove Couplings



Size	Aluminum	Brass	316 Stainless Steel	Ductile Iron	Nylon (yellow)	Polypropylene (black)
1/2"	3E05CAL	3E05CCB	3E05CSS	—	*3E05CNY	*3E05CPP
3/4"	3E07CAL	3E07CCB	3E07CSS	—	3E07CNY	3E07CPP
1"	3E10CAL	3E10CCB	3E10CSS	—	3E10CNY	3E10CPP
1-1/4"	3E12CAL	3E12CCB	3E12CSS	—	**3E12CNY	**3E12CPP
1-1/2"	3E15CAL	3E15CCB	3E15CSS	3E15CDI	3E15CNY	3E15CPP
2"	3E20CAL	3E20CCB	3E20CSS	3E20CDI	3E20CNY	3E20CPP
2-1/2"	3E25CAL	3E25CCB	3E25CSS	—	—	—
3"	3E30CAL	3E30CCB	3E30CSS	3E30CDI	3E30CNY	3E30CPP
4"	3E40CAL	3E40CCB	3E40CSS	3E40CDI	3E40CNY	3E40CPP
5"	3E50CAL	3E50CCB	—	—	—	—
6"	3E60CAL	3E60CCB	3E60CSS	—	—	—
8"	3E80CALA	—	3E80CSS	—	—	—

* 1/2" Nylon and Polypropylene coupler portion is to the 3/4" standard.

** 1-1/4" Nylon and Polypropylene coupler portion is to the 1-1/2" standard.

Stainless Steel handles standard on Tough-TITE® Polypropylene and Nylon couplers.

Brass handles standard on Tough-TITE® Aluminum couplers

U-TITE® Utility Cam and Groove Couplings



Size	Aluminum	Forged Brass	316 Stainless Steel
1/2"	3U05CAL	3U05CFB	3U05CSS
3/4"	3U07CAL	3U07CFB	3U07CSS
1"	3U10CAL	3U10CFB	3U10CSS
1-1/4"	3U12CAL	3U12CFB	3U12CSS
1-1/2"	3U15CAL	3U15CFB	3U15CSS
2"	3U20CAL	3U20CFB	3U20CSS
2-1/2"	3U25CAL	3U25CFB	3U25CSS
3"	3U30CAL	3U30CFB	3U30CSS
4"	3U40CAL	3U40CFB	3U40CSS
5"	3U50CAL	3U50CFB	3U50CSS
6"	3U60CAL	3U60CFB	3U60CSS

Stainless Steel handles Standard on U-TITE® Aluminum couplers

U-tite® Forged Brass and Stainless Steel shank only has major serrations.

EVER-TITE® and U-TITE® Note:

1/2" Aluminum, Brass and Stainless parts are not interchangeable



Don't let the pressure get to you! With over 150 different pressure gauges in our inventory, APG can help you and your customers manage the pressure. Dry, liquid filled, black steel or Stainless Steel – they are all on the shelf.

Part D Female Coupler x Female Thread

EVER-TITE®

Premium Cam and Groove Couplings

Size	Aluminum	Forged Brass	316 Stainless Steel	Polypropylene (black)
1/2"	305DAL	305DBR	305DSS	305DPP
3/4"	307DAL	307DBR	307DSS	307DPP
1"	310DAL	310DBR	310DSS	310DPP
1-1/4"	312DAL	312DBR	312DSS	312DPP
1-1/2"	315DAL	315DBR	315DSS	315DPP
2"	320DAL	320DBR	320DSS	315DPP
2-1/2"	325DAL	325DBR	325DSS	—
3"	330DAL	330DBR	**330DSS	330DPP
4"	340DAL	340DBR	**340DSS	340DPP
5"	350DAL	*350DRB	350DSS	—
6"	360DAL	*360DRB	**360DSS	—
8"	380DAL	—	—	—

*Red Brass

**Available in 4-handle design

Investment Cast 316 Stainless Steel handles standard on EVER-TITE® Aluminum and Polypropylene couplers

Brass handles standard on 8" parts

EVER-TITE® and Tough-TITE® Note:

1/2" Aluminum, Brass and Stainless parts are not interchangeable

8" Aluminum part has 4-handle design

-NPT Standard



EVER-TITE® available options:

Brass Handles, BSP and BST Thread, Monel, Hastelloy C and Carpenter 20® alloy Anodizing (See page 2)

Tough-TITE®

Industrial Cam and Groove Couplings

Size	Aluminum	Brass	316 Stainless Steel	Ductile Iron	Nylon (yellow)	Polypropylene (black)
1/2"	3E05DAL	3E05DCB	3E05DSS	—	*3E05DNY	*3E05DPP
3/4"	3E07DAL	3E07DCB	3E07DSS	—	3E07DNY	3E07DPP
1"	3E10DAL	3E10DCB	3E10DSS	—	3E10DNY	3E10DPP
1-1/4"	3E12DAL	3E12DCB	3E12DSS	—	**3E12DNY	**3E12DPP
1-1/2"	3E15DAL	3E15DCB	3E15DSS	3E15DXDI	3E15DNY	3E15DPP
2"	3E20DAL	3E20DCB	3E20DSS	3E20DXDI	3E20DNY	3E20DPP
2-1/2"	3E25DAL	3E25DCB	3E25DSS	—	—	—
3"	3E30DAL	3E30DCB	3E30DSS	3E30DDI	3E30DNY	3E30DPP
4"	3E40DAL	3E40DCB	3E40DSS	3E40DDI	3E40DNY	3E40DPP
5"	3E50DAL	3E50DCB	—	—	—	—
6"	3E60DAL	3E60DCB	3E60DSS	—	—	—
8"	3E80DALA	—	3E80DSS	—	—	—

* 1/2" Nylon and Polypropylene coupler portion is to the 3/4" standard.

** 1-1/4" Nylon and Polypropylene coupler portion is to the 1-1/2" standard.

Stainless Steel handles standard on Tough-TITE® Polypropylene and Nylon couplers.

Brass handles standard on Tough-TITE® Aluminum couplers



U-TITE®

Utility Cam and Groove Couplings

Size	Aluminum	Forged Brass	316 Stainless Steel
1/2"	3U05DAL	3U05DFB	3U05DSS
3/4"	3U07DAL	3U07DFB	3U07DSS
1"	3U10DAL	3U10DFB	3U10DSS
1-1/4"	3U12DAL	3U12DFB	3U12DSS
1-1/2"	3U15DAL	3U15DFB	3U15DSS
2"	3U20DAL	3U20DFB	3U20DSS
2-1/2"	3U25DAL	3U25DFB	3U25DSS
3"	3U30DAL	3U30DFB	3U30DSS
4"	3U40DAL	3U40DFB	3U40DSS
5"	3U50DAL	3U50DFB	3U50DSS
6"	3U60DAL	3U60DFB	3U60DSS

Stainless Steel handles standard on U-TITE® Polypropylene and Nylon couplers.

EVER-TITE® and U-TITE® Note:

1/2" Aluminum, Brass and Stainless parts are not interchangeable



Call Today!
1-800-888-5223



Part E Male Adapter x Hose Shank



Shoulder now standard on 1-1/2", 2", 3" & 4" Ever-tite Aluminum Part E



EVER-TITE® Premium Cam and Groove Couplings				
Size	Aluminum	Forged Brass	316 Stainless Steel	Polypropylene (black)
1/2"	305EAL	305EBR	305ESS	305EPP
3/4"	307EAL	307EBR	307ESS	307EPP
1"	**310EAL	310EBR	310ESS	310EPP
1-1/4"	312EAL	312ERB	312ESS	312EPP
1-1/2"	**315EAL	315EBR	315ESS	315EPP
2"	**320EAL	320EBR	320ESS	320EPP
2-1/2"	**325EAL	325EBR	325ESS	—
3"	**330EAL	330EBR	330ESS	330EPP
4"	**340EAL	340EBR	340ESS	340EPP
5"	**350EAL	*350ERB	350ESS	—
6"	**360EAL	*360ERB	360ESS	—
8"	380EAL	—	—	—

EVER-TITE® available options:
Monel, Hastelloy C and Carpenter 20® alloy
Adonizing (see page 2)

*Red Brass.
**Machined shanks.

EVER-TITE® and Tough-TITE® Note:
1/2" Aluminum, Brass and Stainless parts are not interchangeable



Tough-TITE® Industrial Cam and Groove Couplings						
Size	Aluminum	Brass	316 Stainless Steel	Ductile Iron	Nylon (yellow)	Polypropylene (black)
1/2"	**3E05EAL	**3E05ECB	**3E05ESS	—	*3E05ENY	*3E05EPP
3/4"	3E07EAL	3E07ECB	3E07ESS	—	3E07ENY	3E07EPP
1"	3E10EAL	3E10ECB	3E10ESS	—	3E10ENY	3E10EPP
1-1/4"	3E12EAL	3E12ECB	3E12ESS	—	**3E12ENY	**3E12EPP
1-1/2"	3E15EAL	3E15ECB	3E15ESS	3E15EDI	3E15ENY	3E15EPP
2"	3E20EAL	3E20ECB	3E20ESS	3E20EXDI	3E20ENY	3E20EPP
2-1/2"	3E25EAL	3E25ECB	3E25ESS	—	—	—
3"	3E30EAL	3E30ECB	3E30ESS	3E30EXDI	3E30ENY	3E30EPP
4"	3E40EAL	3E40ECB	3E40ESS	3E40EXDI	3E40ENY	3E40EPP
5"	3E50EAL	3E50ECB	—	—	—	—
6"	3E60EAL	3E60ECB	3E60ESS	—	—	—
8"	3E80EALA	—	3E80ESS	—	—	—

* 1/2" Nylon and Polypropylene adapter portion is to the 3/4" standard.
** 1-1/4" Nylon and Polypropylene adapter portion is to the 1-1/2" standard.



U-TITE® Utility Cam and Groove Couplings			
Size	Aluminum	Forged Brass	316 Stainless Steel
1/2"	3U05EAL	3U05EFB	3U05ESS
3/4"	3U07EAL	3U07EFB	3U07ESS
1"	3U10EAL	3U10EFB	3U10ESS
1-1/4"	3U12EAL	3U12EFB	3U12ESS
1-1/2"	3U15EAL	3U15EFB	3U15ESS
2"	3U20EAL	3U20EFB	3U20ESS
2-1/2"	3U25EAL	3U25EFB	3U25ESS
3"	3U30EAL	3U30EFB	3U30ESS
4"	3U40EAL	3U40EFB	3U40ESS
5"	3U50EAL	3U50EFB	3U50ESS
6"	3U60EAL	3U60EFB	3U60ESS

U-tite® Forged Brass and Stainless Steel shank only has major serrations.

EVER-TITE® and U-TITE® Note:
1/2" Aluminum, Brass and Stainless parts are not interchangeable

24/7 Call Out Service

CALL US EMAIL FAX WALK-IN

INFO@CALLAPG.COM FAX WILL CALL

"AMERICA'S MOST RESPONSIVE WAREHOUSE"



The APG On-Line Ordering System can be used for much more than just placing orders. Order tracking, quotes, price checks, account information, and more!

Part F Male Adapter x Male Thread

EVER-TITE®

Premium Cam and Groove Couplings

Size	Aluminum	Forged Brass	316 Stainless Steel	Polypropylene (black)
1/2"	305FAL	305FBR	305FSS	305FPP
3/4"	307FAL	307FBR	307FSS	307FPP
1"	310FAL	310FBR	310FSS	310FPP
1-1/4"	312FAL	312FBR	312FSS	312FPP
1-1/2"	315FAL	315FBR	315FSS	315FPP
2"	320FAL	320FBR	320FSS	320FPP
2-1/2"	325FAL	325FBR	325FSS	—
3"	330FAL	330FBR	330FSS	330FPP
4"	340FAL	340FBR	340FSS	340FPP
5"	350FAL	*350FRB	350FSS	—
6"	360FAL	*360FRB	360FSS	—
8"	380FAL	—	—	—

* Red Brass

EVER-TITE® and Tough-TITE® Note:

1/2" Aluminum, Brass and Stainless parts are not interchangeable

-NPT Standard



EVER-TITE® available options:

BSP, BST, & NPSM thread
Monel, Hastelloy C and Carpenter 20® alloy
Anodizing (see page 2)

Tough-TITE®

Industrial Cam and Groove Couplings

Size	Aluminum	Brass	316 Stainless Steel	Ductile Iron	Nylon (yellow)	Polypropylene (black)
1/2"	3E05FAL	3E05FCB	3E05FSS	—	*3E05FNY	*3E05FPP
3/4"	3E07FAL	3E07FCB	3E07FSS	—	3E07FNY	3E07FPP
1"	3E10FAL	3E10FCB	3E10FSS	—	3E10FNY	3E10FPP
1-1/4"	3E12FAL	3E12FCB	3E12FSS	—	**3E12FNY	**3E12FPP
1-1/2"	3E15FAL	3E15FCB	3E15FSS	3E15FDI	3E15FNY	3E15FPP
2"	3E20FAL	3E20FCB	3E20FSS	3E20FDI	3E20FNY	3E20FPP
2-1/2"	3E25FAL	3E25FCB	3E25FSS	—	—	—
3"	3E30FAL	3E30FCB	3E30FSS	3E30FDI	3E30FNY	3E30FPP
4"	3E40FAL	3E40FCB	3E40FSS	3E40FDI	3E40FNY	3E40FPP
5"	3E50FAL	3E50FCB	—	—	—	—
6"	3E60FAL	3E60FCB	3E60FSS	—	—	—
8"	3E80FALA	—	—	—	—	—

* 1/2" Nylon and Polypropylene adapter portion is to the 3/4" standard.

** 1-1/4" Nylon and Polypropylene adapter portion is to the 1-1/2" standard.



U-TITE®

Utility Cam and Groove Couplings

Size	Aluminum	Forged Brass	316 Stainless Steel
1/2"	3U05FAL	3U05FFB	3U05FSS
3/4"	3U07FAL	3U07FFB	3U07FSS
1"	3U10FAL	3U10FFB	3U10FSS
1-1/4"	3U12FAL	3U12FFB	3U12FSS
1-1/2"	3U15FAL	3U15FFB	3U15FSS
2"	3U20FAL	3U20FFB	3U20FSS
2-1/2"	3U25FAL	3U25FFB	3U25FSS
3"	3U30FAL	3U30FFB	3U30FSS
4"	3U40FAL	3U40FFB	3U40FSS
5"	3U50FAL	3U50FFB	3U50FSS
6"	3U60FAL	3U60FFB	3U60FSS

EVER-TITE® and U-TITE® Note:

1/2" Aluminum, Brass and Stainless parts are not interchangeable





Part DC Dust Cap



EVER-TITE® available options:
Brass handles
Monel, Hastelloy C and Carpenter 20® alloy
Anodizing (see page 2)

EVER-TITE® Premium Cam and Groove Couplings

Size	Aluminum	Forged Brass	316 Stainless Steel	Polypropylene (black)
1/2"	305DCAL	305DCBR	305DCSS	—
3/4"	307DCAL	307DCBR	307DCSS	307DCPP
1"	310DCAL	310DCBR	310DCSS	310DCPP
1-1/4"	312DCAL	312DCBR	312DCSS	312DCPP
1-1/2"	315DCAL	315DCBR	315DCSS	315DCPP
2"	320DCAL	320DCBR	320DCSS	320DCPP
2-1/2"	325DCAL	325DCBR	325DCSS	—
3"	330DCAL	330DCBR	330DCSS	330DCPP
4"	340DCAL	340DCBR	340DCSS	340DCPP
5"	350DCAL	*350DCRB	350DCSS	—
6"	360DCAL	*360DCRB	360DCSS	—
8"	380DCAL	—	—	—

*Red Brass
Investment Cast Stainless Steel handles standard on EVER-TITE® Aluminum couplers
Brass handles standard on 8" parts

EVER-TITE® and Tough-TITE® Note:
1/2" Aluminum, Brass and Stainless Steel Parts are not Interchangeable.

Tough-TITE® Industrial Cam and Groove Couplings



Size	Aluminum	Brass	316 Stainless Steel	Ductile Iron	Nylon (yellow)	Polypropylene (black)
1/2"	3E05DCAL	3E05DCCB	3E05DCSS	—	—	—
3/4"	3E07DCAL	3E07DCCB	3E07DCSS	—	3E07DCNY	3E07DCPP
1"	3E10DCAL	3E10DCCB	3E10DCSS	—	3E10DCNY	3E10DCPP
1-1/4"	3E12DCAL	3E12DCCB	3E12DCSS	—	*3E12DCNY	—
1-1/2"	3E15DCAL	3E15DCCB	3E15DCSS	3E15DCDI	3E15DCNY	3E15DCPP
2"	3E20DCAL	3E20DCCB	3E20DCSS	3E20DCDI	3E20DCNY	3E20DCPP
2-1/2"	3E25DCAL	3E25DCCB	3E25DCSS	—	—	—
3"	3E30DCAL	3E30DCCB	3E30DCSS	3E30DCDI	3E30DCNY	3E30DCPP
4"	3E40DCAL	3E40DCCB	3E40DCSS	3E40DCDI	3E40DCNY	3E40DCPP
5"	3E50DCAL	3E50DCCB	—	—	—	—
6"	3E60DCAL	3E60DCCB	3E60DCSS	—	—	—
8"	3E80DCALA	—	3E80DCSS	—	—	—

*1-1/4" Nylon coupler portion is to the 1-1/2" standard
Stainless Steel handles standard on Tough-TITE® Polypropylene and Nylon couplers.
Brass handles standard on Tough-TITE® Aluminum couplers

U-TITE® Utility Cam and Groove Couplings



Size	Aluminum	Forged Brass	316 Stainless Steel
1/2"	3U05DCAL	3U05DCFB	3U05DCSS
3/4"	3U07DCAL	3U07DCFB	3U07DCSS
1"	3U10DCAL	3U10DCFB	3U10DCSS
1-1/4"	3U12DCAL	3U12DCFB	3U12DCSS
1-1/2"	3U15DCAL	3U15DCFB	3U15DCSS
2"	3U20DCAL	3U20DCFB	3U20DCSS
2-1/2"	3U25DCAL	3U25DCFB	3U25DCSS
3"	3U30DCAL	3U30DCFB	3U30DCSS
4"	3U40DCAL	3U40DCFB	3U40DCSS
5"	3U50DCAL	3U50DCFB	3U50DCSS
6"	3U60DCAL	3U60DCFB	3U60DCSS

Stainless Steel handles standard on U-TITE® Aluminum couplers

EVER-TITE® and U-TITE® Note:
1/2" Aluminum, Brass and Stainless parts are not interchangeable

ONLINE ORDER & TRACKING!



CALL US



EMAIL



FAX



WALK-IN

"AMERICA'S MOST RESPONSIVE WAREHOUSE"



When many people think of APG EVER-TITE® couplings, they think “Cam and Groove Couplings.” And this is great, because they are the best cam and groove values on the market. But don't forget all the other products in our Industrial Hose Coupling Catalog.

Part DP Dust Plug

EVER-TITE® Premium Cam and Groove Couplings

Size	Aluminum	Forged Brass	316 Stainless Steel	Polypropylene (black)
1/2"	305DPAL	305DPBR	305DPSS	—
3/4"	307DPAL	307DPBR	307DPSS	307DPPP
1"	310DPAL	310DPBR	310DPSS	310DPPP
1-1/4"	312DPAL	312DPBR	312DPSS	312DPPP
1-1/2"	315DPAL	315DPBR	315DPSS	315DPPP
2"	320DPAL	320DPBR	320DPSS	320DPPP
2-1/2"	325DPAL	325DPBR	325DPSS	—
3"	330DPAL	330DPBR	330DPSS	330DPPP
4"	340DPAL	340DPBR	340DPSS	340DPPP
5"	350DPAL	*350DPRB	350DPSS	—
6"	360DPAL	*360DPRB	360DPSS	—
8"	380DPAL	—	—	—

* Red Brass.

EVER-TITE® and Tough-TITE® Note:

1/2" Aluminum, Brass and Stainless parts are not interchangeable

Tough-TITE®

Industrial Cam and Groove Couplings

Size	Aluminum	Brass	316 Stainless Steel	Ductile Iron	Nylon (yellow)	Polypropylene (black)
1/2"	3E05DPAL	3E05DPCB	3E05DPSS	—	—	—
3/4"	3E07DPAL	3E07DPCB	3E07DPSS	—	3E07DPNY	3E07DPPP
1"	3E10DPAL	3E10DPCB	3E10DPSS	—	3E10DPNY	3E10DPPP
1-1/4"	3E12DPAL	3E12DPCB	3E12DPSS	—	—	—
1-1/2"	3E15DPAL	3E15DPCB	3E15DPSS	3E15DPDI	3E15DPNY	3E15DPPP
2"	3E20DPAL	3E20DPCB	3E20DPSS	3E20DPDI	3E20DPNY	3E20DPPP
2-1/2"	3E25DPAL	3E25DPCB	3E25DPSS	—	—	—
3"	3E30DPAL	3E30DPCB	3E30DPSS	3E30DPDI	3E30DPNY	3E30DPPP
4"	3E40DPAL	3E40DPCB	3E40DPSS	3E40DPDI	3E40DPNY	3E40DPPP
5"	3E50DPAL	3E50DPCB	—	—	—	—
6"	3E60DPAL	3E60DPCB	3E60DPSS	—	—	—
8"	—	—	3E80DPSS	—	—	—

U-TITE®

Utility Cam and Groove Couplings

Size	Aluminum	Forged Brass	316 Stainless Steel
1/2"	3U05DPAL	3U05DPFB	3U05DPSS
3/4"	3U07DPAL	3U07DPFB	3U07DPSS
1"	3U10DPAL	3U10DPFB	3U10DPSS
1-1/4"	3U12DPAL	3U12DPFB	3U12DPSS
1-1/2"	3U15DPAL	3U15DPFB	3U15DPSS
2"	3U20DPAL	3U20DPFB	3U20DPSS
2-1/2"	3U25DPAL	3U25DPFB	3U25DPSS
3"	3U30DPAL	3U30DPFB	3U30DPSS
4"	3U40DPAL	3U40DPFB	3U40DPSS
5"	3U50DPAL	3U50DPFB	3U50DPSS
6"	3U60DPAL	3U60DPFB	3U60DPSS

EVER-TITE® and U-TITE® Note:

1/2" Aluminum, Brass and Stainless parts are not interchangeable

NOT to be used in pressure applications



EVER-TITE® available options:

Brass handles
Monel, Hastelloy C and Carpenter 20® alloy
Anodizing (see page 2)



Cam and Groove Couplings

EVER-TITE® Locking Handle Couplers

Model 101

Double-Locking Handle Bleed-Off Couplers

The ONLY bleed-off coupler available

- Extra security – two sets of locking handles
- Releasing one set of handles will bleed off hose pressure
- During bleed-off, handles can be securely reclosed

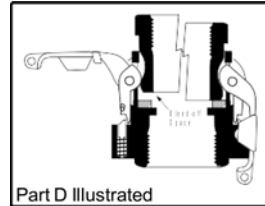

Part D Illustrated

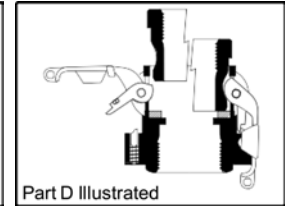

Part D Illustrated

Lift up the outer set of handles into the bleed-off position while the locked inner handles hold the adapter within the coupling.

When fully bled-off, pull down on the latch button (not shown) to release the inner set of handles, held by the spring-loaded latch, allowing the coupling to be fully disconnected.



Size	Part C			Part D		
	Aluminum	Forged Brass	316 Stainless Steel	Aluminum	Brass	316 Stainless Steel
1"	—	—	310CLHSS101	—	—	310DLHSS101
1-1/2"	315CLHAL101	—	315CLHSS101	315DLHAL101	—	315DLHSS101
2"	320CLHAL101	—	320CLHSS101	320DLHAL101	—	320DLHSS101
2-1/2"	—	—	325CLHSS101	—	—	325DLHSS101
3"	330CLHAL101	—	330CLHSS101	330DLHAL101	—	330DLHSS101
4"	340CLHAL101	—	340CLHSS101	340DLHAL101	—	340DLHSS101

Model 102

Positive-Locking Handle Couplers

The industry standard for locking handle couplers

- Most secure locking handle design available
- Requires NO special action to close
- Deliberate release of locking mechanism required to open

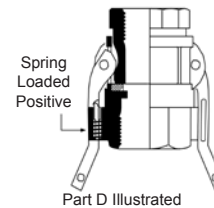

Part D Illustrated

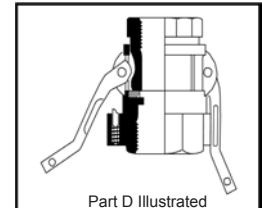

Part D Illustrated

Coupling and male adapter in the locked position. The handles cannot be inadvertently pulled open.

To release the lock, pull down on the latch buttons and lift up the handles.



Part C



Part D

Size	Part C			Part D		
	Aluminum	Forged Brass	316 Stainless Steel	Aluminum	Brass	316 Stainless Steel
1"	—	—	310CLHSS102	—	*310DLHFBR102	310DLHSS102
1-1/2"	315CLHAL102	—	315CLHSS102	315DLHAL102	*315DLHFBR102	315DLHSS102
2"	320CLHAL102	—	320CLHSS102	320DLHAL102	—	320DLHSS102
2-1/2"	—	—	325CLHSS102	—	325DLHBR102	325DLHSS102
3"	330CLHAL102	—	330CLHSS102	330DLHAL102	—	330DLHSS102
4"	340CLHAL102	—	340CLHSS102	340DLHAL102	—	340DLHSS102

* Forged Brass

Joint Sales Calls!!



CALL US



EMAIL



FAX



WALK-IN

"AMERICA'S MOST RESPONSIVE WAREHOUSE"



With many companies operating with lower inventories these days, the large inventories at APG are more important than ever to our customers. As always, we plan to have what you need in stock with same or next day shipping – exactly what you expect from “America’s Most Responsive Warehouse.”

Cam and Groove Couplings

Positive-Locking Handle Couplers

Transform a standard 3”-5” EVER-TITE® or TOUGH-TITE® coupler into a positive locking handle coupler. An alternative to the 102; the same locking enhancement but on a standard coupler. Call TODAY for details

Tough-TITE® Locking Handle Couplers

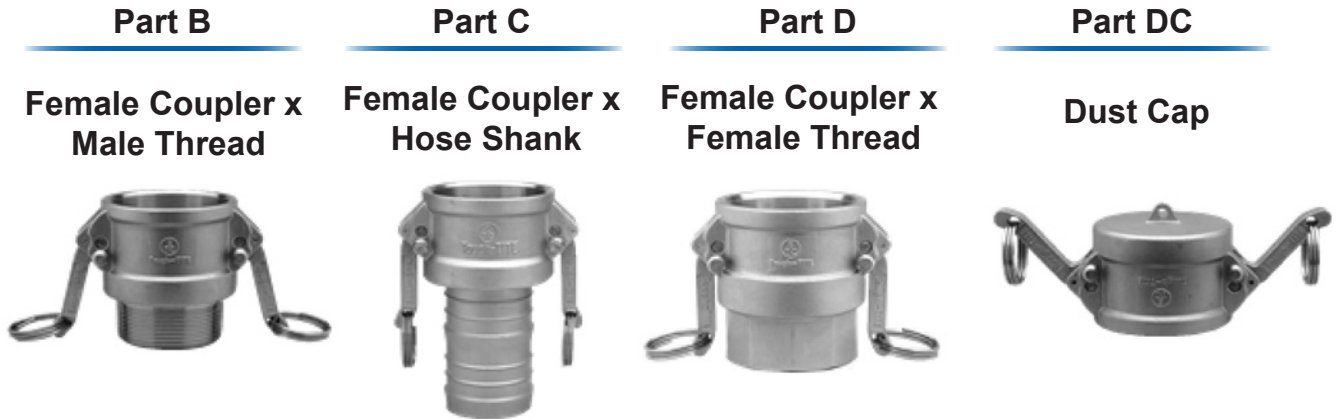

316 Stainless Steel				
Size	Part B	Part C	Part D	Part DC
1-1/4"	3E12BLHSS	3E12CLHSS	3E12DLHSS	3E12DCLHSS
1-1/2"	3E15BLHSS	3E15CLHSS	3E15DLHSS	3E15DCLHSS
2"	3E20BLHSS	3E20CLHSS	3E20DLHSS	3E20DCLHSS
2-1/2"	3E25BLHSS	3E25CLHSS	3E25DLHSS	3E25DCLHSS
3"	3E30BLHSS	3E30CLHSS	3E30DLHSS	3E30DCLHSS
4"	3E40BLHSS	3E40CLHSS	3E40DLHSS	3E40DCLHSS
6"	3E60BLHSS	3E60CLHSS	3E60DLHSS	3E60DCLHSS

Safety Clips can be used with locking handle couplers. (Included)
Tough-Tite® Locking Handle Couplers subject to availability.

Overlocking Handles for Dust Caps

Size	Brass	Aluminum	304 Stainless Steel
1-1/4", 1-1/2"	—	—	3THOL250
2"	320HBRL	—	3THOL250
2-1/2"	—	—	3THOL250
3"	330HBRL	—	3THOL400
4"	340HBRL	—	3THOL400
6"	—	360HSSL	3THOL600

Can be added to any Ever-Tite® or Tough-Tite® dust cap. Contact APG for more information.



Cam and Groove Couplings

Increases/Reducers



		EVER-TITE®			Tough-TITE®	
Part	Size Adapter/Thread	Aluminum	Brass	316 Stainless Steel	Aluminum	316 Stainless Steel
A	3/4" x 1/2"	—	30705ABR	30705ASS	—	—
	1" x 2"	31020AAL	—	—	—	—
	2" x 1-1/2"	32015AAL	32015ABR	—	—	—
	2" x 3"	32030AAL	32030ABR	32030ASS	—	—
	2-1/2" x 3"	32530AAL	—	—	—	—
	3" x 2"	33020AAL	33020ABR	—	3E3020AAL	—
	3" x 2-1/2"	33025AAL	—	—	—	—
	3" x 4"	33040AAL	33040ABR	33040ASS	3E3040AAL	—
	4" x 3"	34030AAL	34030ABR	—	3E4030AAL	—
B	2" x 1-1/2"	△32015BAL	—	—	3E2015BAL	—
	3" x 2"	33020BAL	—	—	3E3020BAL	—
	3" x 2-1/2"	—	33025BBR	—	—	—
	3" x 4"	—	—	—	3E3040BAL	—
	4" x 3"	34030BAL	34030BBR	—	3E4030BAL	—
C	1-1/2" x 1"	31510CAL	31510CBR	—	—	—
	2" x 2-1/2"	32025CAL	—	—	—	—
	3" x 2"	33020CAL	—	—	3E3020CAL	—
	3" x 2-1/2"	33025CAL	33025CBR	—	3E3025CAL	3E3025CSS
	3" x 3-1/2"	33035CAL	—	—	—	—
	3" x 4"	—	33040CBR	—	3E3040CAL	—
	4" x 3"	34030CAL	34030CBR	—	3E4030CAL	—
	4" x 3-1/2"	34035CAL	34035CBR	—	—	—
D	3/4" x 1/2"	30705DAL	30705DBR	—	—	—
	2" x 1-1/2"	32015DAL	—	—	3E2015DAL	—
	2-1/2" x 2"	32520DAL	—	—	—	—
	3" x 2"	33020DAL	33020DBR	33020DSS	3E3020DAL	—
	3" x 2-1/2"	33025DAL	—	—	—	—
	4" x 2"	—	—	34020DSS	—	—
	4" x 2-1/2"	34020DAL	—	—	—	—
	4" x 3"	34030DAL	34030DBR	—	3E4030DAL	—
E	3" x 2"	—	—	—	3E3020EAL	—
	3" x 2-1/2"	33025EAL	—	—	—	3E3025ESS
	3" x 4"	33040EAL	33040EBR	—	—	—
	4" x 3"	—	34030EBR	—	3E4030EAL	—
	4" x 3-1/2"	34035EAL	—	—	—	—
F	1-1/2" x 2"	31520FAL	—	—	—	—
	2" x 1-1/2"	32015FAL	32015FBR	—	3E2015FAL	—
	3" x 1-1/5"	33015FAL	—	—	3E3015FAL	—
	3" x 2"	33020FAL	33020FBR	—	3E3020FAL	—
	3" x 2-1/2"	33025FAL	—	—	—	—
	3" x 4"	33040FAL	—	—	3E3040FAL	—
	4" x 3"	34030FAL	34030FBR	—	—	—

△ The standard EVER-TITE® 2" x 1-1/2" Aluminum part B is pictured.

A MII-Spec version is available with a longer shank containing the thread component and a hex nut.



APG universal crowfoot couplings (or "Chicago" fittings as they are commonly called) have easily established a reputation of superiority in the marketplace. They are low carbon steel as opposed to ductile iron – allowing a machined finish beneath the grommet which provides a better seal. And this added benefit even comes with a less expensive price tag!

Cam and Groove Couplings

Size	EVER-TITE®		Tough-TITE®		
	Aluminum	316 Stainless Steel	Brass	Aluminum	316 Stainless Steel
1 x 1	—	310SASS	—	3E10SAAL	3E10SASS
1-1/4 x 1-1/4	—	312SASS	—	3E12SAAL	3E12SASS
1-1/2 X 1-1/2	315SAAL	315SASS	—	3E15SAAL	3E15SASS
1-1/2 x 2	31520SAAL	—	—	3E1520SAAL	3E1520SASS
2 x 2	320SAAL	320SASS	3E20SABR	3E20SAAL	3E20SASS
2 x 2-1/2	—	—	—	3E2025SAAL	—
2 x 3	—	32030SASS	—	3E2030SAAL	3E2030SASS
2 x 4	32040SAAL	—	—	—	—
2-1/2 x 2-1/2	—	—	—	—	—
2-1/2 x 3	32530SAAL	—	—	—	—
3 x 3	330SAAL	330SASS	3E30SABR	3E30SAAL	3E30SASS
3 x 4	33040SAAL	—	—	3E3040SAAL	3E3040SASS
4 x 4	340SAAL	—	—	3E40SAAL	3E40SASS
4 x 5	—	—	—	—	—
4 x 6	—	—	—	3E4060SAAL	—
6 x 6	360SAAL	—	—	3E60SAAL	—

Spool Adapter

*Part SA



Spool Coupler

*Part BB



Size	EVER-TITE®		Tough-TITE®	
	Aluminum	316 Stainless Steel	Aluminum	316 Stainless Steel
1-1/2 x 1-1/2	315BBAL	—	3E15BBAL	3E15BBSS
2 x 2	—	320BBSS	3E20BBAL	3E20BBSS
2 x 3	—	—	—	3E2030BBSS
3 x 3	330BBAL	330BBSS	3E30BBAL	3E30BBSS
4 x 4	340BBAL	—	3E40BBAL	3E40BBSS
4 x 3	34030BBAL	—	—	—

Coupler/Adapter

*Part BA
Female Coupler/Male Adapter

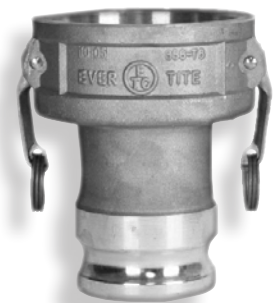

Size	EVER-TITE®		Tough-TITE®	
	Aluminum	316 Stainless Steel	Aluminum	316 Stainless Steel
1-1/2 x 2	31520BAAL	—	3E1520BAAL	—
2 x 1-1/2	32015BAAL	32015BASS	3E2015BAAL	3E2015BASS
2 x 3	32030BAAL	—	3E2030BAAL	3E2030BASS
2 x 4	—	—	3E2040BAAL	3E2040BASS
3 x 1-1/2	—	—	3E3015BAAL	3E3015BASS
3 x 2	33020BAAL	33020BASS	3E3020BAAL	3E3020BASS
3 x 2-1/2	—	—	3E3025BAAL	3E3025BASS
3 x 4	33040BAAL	—	3E3040BAAL	3E3040BASS
4 x 2	—	—	3E4020BAAL	3E4020BASS
4 x 3	34030BAAL	34030BASS	3E4030BAAL	3E4030BASS
4 x 6	34060BAAL	—	3E4060BAAL	—
5 x 4	35040BAAL	—	—	—
6 x 4	36040BAAL	—	3E6040BAAL	3E6040BASS
6 x 5	—	—	—	—



CALL US



EMAIL



FAX



WALK-IN

"AMERICA'S MOST RESPONSIVE WAREHOUSE"



Cam and Groove Couplings

EVER-TITE® Premium Butt Weld & Socket Weld Couplings

**Part A
Butt Weld**



**Part D
Butt Weld**



Size	Part A Adapter				Part D Coupler			
	Butt Weld				Butt Weld			
	Tube		Pipe		Tube		Pipe	
	Aluminum	316 Stainless Steel	Aluminum	316 Stainless Steel	Aluminum	316 Stainless Steel	Aluminum	316 Stainless Steel
3/4	307ABWALT	307ABWSST	307ABWALP10 307ABWALP40	307ABWSSP10 307ABWSSP40	307DBWALT	307DBWSST	307DBWALP10 307DBWALP40	307DBWSSP10 307DBWSSP40
1	310ABWALT	310ABWSST	310ABWALP10 310ABWALP40	310ABWSSP10 310ABWSSP40	310DBWALT	310DBWSST	310DBWALP10 310DBWALP40	310DBWSSP10 310DBWSSP40
1-1/2	315ABWALT	315ABWSST	315ABWALP10 315ABWALP40	315ABWSSP10 315ABWSSP40	315DBWALT	315DBWSST	315DBWALP10 315DBWALP40	315DBWSSP10 315DBWSSP40
2	320ABWALT	320ABWSST	320ABWALP10 320ABWALP40	320ABWSSP10 320ABWSSP40	320DBWALT	320DBWSST	320DBWALP10 320DBWALP40	320DBWSSP10 320DBWSSP40
2-1/2	325ABWALT	325ABWSST	325ABWALP10 325ABWALP40	325ABWSSP10 325ABWSSP40	325DBWALT	325DBWSST	325DBWALP10 325DBWALP40	325DBWSSP10 325DBWSSP40
3	330ABWALT	330ABWSST	330ABWALP10 330ABWALP40	330ABWSSP10 330ABWSSP40	330DBWALT	330DBWSST	330DBWALP10 330DBWALP40	330DBWSSP10 330DBWSSP40
4	340ABWALT	340ABWSST	340ABWALP10 340ABWALP40	340ABWSSP10 340ABWSSP40	340DBWALT	340DBWSST	340DBWALP10 340DBWALP40	340DBWSSP10 340DBWSSP40
5	350ABWALT	350ABWSST	350ABWALP10 350ABWALP40	350ABWSSP10 350ABWSSP40	350DBWALT	350DBWSST	350DBWALP10 350DBWALP40	350DBWSSP10 350DBWSSP40
6	360ABWALT	360ABWSST	360ABWALP10 360ABWALP40	360ABWSSP10 360ABWSSP40	360DBWALT	360DBWSST	360DBWALP10 360DBWALP40	360DBWSSP10 360DBWSSP40

Note: Additional Butt Weld Pipe Sizes Available Upon Request; i.e., Schedule 5 and 80. Part numbers ending in 10 are to schedule 10 pipe. Part numbers ending in 40 are to schedule 40 pipe.

**Part A
Socket Weld**



**Part D
Socket Weld**



SIZE	Part A Adapter				Part D Coupler			
	Socket Weld				Socket Weld			
	Tube		Pipe		Tube		Pipe	
	Aluminum	316 Stainless Steel	Aluminum	316 Stainless Steel	Aluminum	316 Stainless Steel	Aluminum	316 Stainless Steel
3/4	307ASWALT	307ASWSST	307ASWALP	307ASWSSP	307DSWALT	307DSWSST	307DSWALP	307DSWSSP
1	310ASWALT	310ASWSST	310ASWALP	310ASWSSP	310DSWALT	310DSWSST	310DSWALP	310DSWSSP
1-1/2	315ASWALT	315ASWSST	315ASWALP	315ASWSSP	315DSWALT	315DSWSST	315DSWALP	315DSWSSP
2	320ASWALT	320ASWSST	320ASWALP	320ASWSSP	320DSWALT	320DSWSST	320DSWALP	320DSWSSP
2-1/2	325ASWALT	325ASWSST	325ASWALP	325ASWSSP	325DSWALT	325DSWSST	325DSWALP	325DSWSSP
3	330ASWALT	330ASWSST	330ASWALP	330ASWSSP	330DSWALT	330DSWSST	330DSWALP	330DSWSSP
4	340ASWALT	340ASWSST	340ASWALP	340ASWSSP	340DSWALT	340DSWSST	340DSWALP	340DSWSSP
5	350ASWALT	350ASWSST	350ASWALP	350ASWSSP	350DSWALT	350DSWSST	350DSWALP	350DSWSSP
6	360ASWALT	360ASWSST	360ASWALP	360ASWSSP	360DSWALT	360DSWSST	360DSWALP	360DSWSSP



APG universal crowfoot couplings (or “Chicago” fittings as they are commonly called) have easily established a reputation of superiority in the marketplace. They are low carbon steel as opposed to ductile iron – allowing a machined finish beneath the grommet which provides a better seal. And this added benefit even comes with a less expensive price tag!

Cam and Groove Couplings

Tough-TITE® Industrial Socket Weld Couplings

**Part A
Tube
Socket Weld**



**Part A
Pipe
Socket Weld**



**Part D
Tube
Socket Weld**



**Part D
Pipe
Socket Weld**



Size	Part A Adapter				Part D Coupler			
	Tube Socket Weld		Pipe Socket Weld		Tube Socket Weld		Pipe Socket Weld	
	Aluminum	316 Stainless Steel	Aluminum	316 Stainless Steel	Aluminum	316 Stainless Steel	Aluminum	316 Stainless Steel
1-1/2	3E15ASWALT	3E15ASWSST	3E15ASWALP	3E15ASWSSP	3E15DSWALT	3E15DSWSST	3E15DSWALP	3E15DSWSSP
2	3E20ASWALT	3E20ASWSST	3E20ASWALP	3E20ASWSSP	3E20DSWALT	3E20DSWSST	3E20DSWALP	3E20DSWSSP
2-1/2	3E25ASWALT	3E25ASWSST	3E25ASWALP	3E25ASWSSP	3E25DSWALT	3E25DSWSST	3E25DSWALP	3E25DSWSSP
3	3E30ASWALT	3E30ASWSST	3E30ASWALP	3E30ASWSSP	3E30DSWALT	3E30DSWSST	3E30DSWALP	3E30DSWSSP
4	3E40ASWALT	3E40ASWSST	3E40ASWALP	3E40ASWSSP	3E40DSWALT	3E40DSWSST	3E40DSWALP	3E40DSWSSP
5	3E50ASWALT	—	3E50ASWALP	—	3E50DSWALT	—	3E50DSWALP	—
6	3E60ASWALT	3E60ASWSST	3E60ASWALP	3E60ASWSSP	3E60DSWALT	3E60DSWSST	3E60DSWALP	3E60DSWSSP



“America’s Most Responsive Warehouse”



CALL US



EMAIL



FAX



WALK-IN

Cam and Groove Couplings

EVER-TITE® Heavy Duty Brass Couplings

Size	Brass				Gasket Buna
	Part A	Part D	Dust Cap	Dust Plug	
1"	310AXB	310DXB	310DCXB	310DPXB	310GSKBUHD
1-1/4"	—	—	—	—	312GSKBUHD
1-1/2"	315AXB	315DXB	—	—	315GSKBUHD
2"	320AXB	320DXB	320DCXB	320DPXB	320GSKBUHD
2-1/2"	—	—	—	—	325GSKBUHD
3"	330AXB	330DXB	330DCXB	330DPXB	330GSKBUHD
4"	340AXB	—	—	—	340GSKBUHD

Not
interchangeable
with standard
cam and groove
couplings.
3/4" through 2"
sizes include
handle rings.

Tough-TITE® Heavy Duty Ductile Iron Couplings

- Provides durability in abrasive applications
- High Pressure performance versus standard ductile iron.
- Coating provides corrosion resistance

**NEW
PRODUCT**



Size	Heavy Duty Ductile Iron				Working Pressure (PSI)
	Part A	Part C	Part D	Part E	
3/4"	3E07AXDI	—	3E07DXDI	—	—
1"	3E10AXDI	—	3E10DXDI	—	500
1-1/4"	3E12AXDI	—	3E12DXDI	—	500
1-1/2"	3E15AXDI	—	3E15DXDI	—	500
2" x 1-1/2"	3E2015AXDI	—	3E2015DXDI	—	500
2"	3E20AXDI	3E20CXDI	3E20DXDI	3E20EXDI	500
3"	—	3E30CXDI	—	3E30EXDI	400
4"	—	3E40CXDI	—	3E40EXDI	250

- standard working temperature 225° F with standard buna gasket



Need brass swing check valves? They are on the shelf at APG in seven sizes from 1/2" through 3" inch – ready for same or next day shipment.

Cam and Groove Couplings

EVER-TITE® 90° Part A

Male Adapter x Female Thread

Size	Brass	Aluminum
1-1/2"	—	315A90AL
2"	320A90BR	320A90AL
3"	330A90BR	330A90AL
4"	—	340A90AL



EVER-TITE® 90° Part C

Female Coupler x Hose Shank

Size	Brass	Aluminum	316 Stainless Steel	Brass
1-1/4"	312C90BR	—	—	3E12C90CB
1-1/2"	315C90BR	315C90AL	—	—
2"	320C90BR	320C90AL	—	—
3"	—	330C90AL	330C90SS	—
4"	340C90BR	340C90AL	—	—



EVER-TITE® 90° Part D

Female Coupler x Female Thread

Size	Brass	Aluminum	316 Stainless Steel
1-1/4"	312D90BR	—	—
1-1/2"	315D90BR	315D90AL	315D90SS
2"	320D90BR	320D90AL	320D90SS
2-1/2"	325D90BR	325D90AL	—
3"	330D90BR	330D90AL	330D90SS
4"	—	340D90AL	340D90SS
6"	—	360D90AL	—



EVER-TITE® 90° Spool Coupler

Part BB

Size	Aluminum
2"	320BB90AL
3"	330BB90AL
4"	340BB90AL
6"	360BB90AL



EVER-TITE® 90° Coupler/Adapter

Part BA

Female Coupler x Male Adapter

Size	Brass	Aluminum
2"	—	320BA90AL
4"	—	340BA90AL
6"	—	360BA90AL

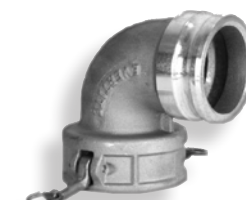

EVER-TITE® Cam and Groove Couplings

No. 99 Tight-Fill Couplings

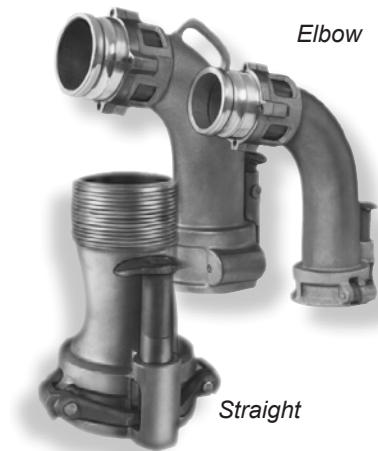

Aluminum Body, Brass parts

Part Number	Description
33099SGALNIE	3" x 100° x 8-1/2" Clearance sight gauge - no inlet end
33099SGALAIE	3" x 100° x 8-1/2" Clearance sight gauge - 3" adapter inlet end
33099SGALCIE	3" x 100° x 8-1/2" Clearance sight gauge - 3" coupler inlet end
33099SGAL40AIE	3" x 100° x 8-1/2" Clearance sight gauge - 4" adapter inlet end
33099SGAL40CIE	3" x 100° x 8-1/2" Clearance sight gauge - 4" coupler inlet end
33099SGALMT*	3" x 100° x 8-1/2" Clearance sight gauge - male threaded inlet end
33099SGALFT*	3" x 100° x 8-1/2" Clearance sight gauge - female threaded inlet end
33099SAL	3" Straight (no sight gauge) male threaded inlet only
34099SAL	4" Straight (no sight gauge) male threaded inlet only
34099SGALNIE	4" x 100° x 12-1/2" Clearance sight gauge - no inlet end
34099SGALAIE*	4" x 100° x 12-1/2" Clearance sight gauge - 4" adapter inlet end
34099SGALCIE*	4" x 100° x 12-1/2" Clearance sight gauge - 4" coupler inlet end
34099SGAL30AIE*	4" x 100° x 12-1/2" Clearance sight gauge - 3" adapter inlet end
34099SGAL30CIE*	4" x 100° x 12-1/2" Clearance sight gauge - 3" coupler inlet end
34099SGALMTIE*	4" x 100° x 12-1/2" Clearance sight gauge - male threaded inlet end
34099SGALFTIE*	4" x 100° x 12-1/2" Clearance sight gauge - female threaded inlet end
34099SAL	4" Straight (no sight gauge) male threaded inlet only

Stirrup handle available assembled on 4" SG's only

Parts for No. 99 Elbow Couplings

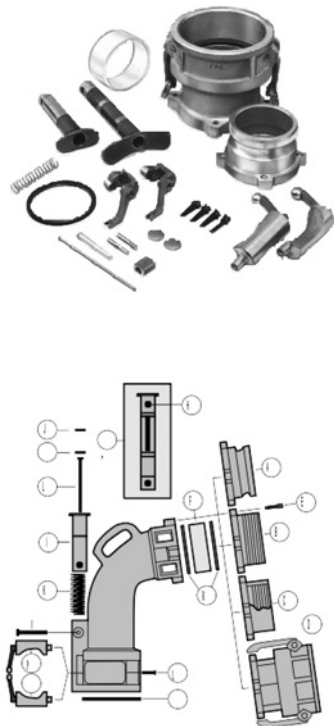

Diagram Reference	Part Number		Description
	3"	4"	
A	330AIEAL99	340AIEAL99	Adapter inlet end only
A	340AIEAL3099	—	4" Adapter inlet end for 3" No. 99
A	—	330AIEAL4099	3" Adapter inlet end for 4" No. 99
B	330MIEAL99	340MTIEAL99	Male threaded inlet end only
C	—	340FTIEAL99	Female threaded adapter inlet end only
D	330CIEAL99	340CIEAL99	Coupler inlet ends only
D	340CIEAL3099	—	4" Coupler inlet end for 3" No. 99
D	—	330CIEAL4099	3" Coupler inlet end for 4" No. 99
E	330SCRXX99	340SCRXX99	Screws for inlet end (set of four)
F	330PSXX99	340PSXX99	Plexiglas® shell only
G	—	340HBR99PLT	Plunger (T-handle)
H	—	340SPBR99	Spacer
I	330PLBR99	—	Plunger
J	—	340CAPB—R99	Cap
K	330SPRXX99	340SPRXX99	Spring
L	330RODXX99	—	Rod
M	330DISCBR99	—	Disc
N	330PSSH	—	Headed Pin
O	330GSKBUMS	340GSKBU99	Coupler gasket
P	330HBRLF99	340HBRLF99	Left Handle
Q	330HBRRT99	340HBRRT99	Right Handle
R	330GSKBUSG99	340GSKBU97AGM	Buna Gasket
(U)S	—	340HBR99PLSL	Stirrup handle assembly available



APG universal crowfoot couplings (or “Chicago” fittings as they are commonly called) have easily established a reputation of superiority in the marketplace. They are low carbon steel as opposed to ductile iron – allowing a machined finish beneath the grommet which provides a better seal. And this added benefit even comes with a less expensive price tag!

Tight-Fill Couplings

Assemblies Without Extension Kits		Assemblies with Extension Kits	
Part Number	Description	Part Number	Description
340TFALNR	4" TF Elbow with Sight Glass No Inlet End - Right Hand	340TFALNRK	4" TF Elbow with Sight Glass and Ext Kit No Inlet End - Right Hand
340TFALNL	4" TF Elbow with Sight Glass No Inlet End - Left Hand	340TFALNLK	4" TF Elbow with Sight Glass and Ext Kit No Inlet End - Left Hand
340TFALAR	4" TF Elbow with Sight Glass 4" Adapter Inlet End - Right Hand	340TFALARK	4" TF Elbow with Sight Glass and Ext Kit 4" Adapter Inlet End - Right Hand
340TFALAL	4" TF Elbow with Sight Glass 4" Adapter Inlet End - Left Hand	340TFALALK	4" TF Elbow with Sight Glass and Ext Kit 4" Adapter Inlet End - Left Hand
340TFALCR	4" TF Elbow with Sight Glass 4" Coupler Inlet End - Right Hand	340TFALCRK	4" TF Elbow with Sight Glass and Ext Kit 4" Coupler Inlet End - Right Hand
340TFALCL	4" TF Elbow with Sight Glass 4" Coupler Inlet End - Left Hand	340TFALCLK	4" TF Elbow with Sight Glass and Ext Kit 4" Coupler Inlet End - Left Hand
340TFALMR	4" TF Elbow with Sight Glass Male Threaded Inlet End - Right Hand	340TFALMRK	4" TF Elbow with Sight Glass and Ext Kit Male Threaded Inlet End - Right Hand
340TFALML	4" TF Elbow with Sight Glass Male Threaded Inlet End - Left Hand	340TFALMLK	4" TF Elbow with Sight Glass and Ext Kit Male Threaded Inlet End - Left Hand
340TFALFR	4" TF Elbow with Sight Glass Female Threaded Inlet End - Right Hand	340TFALFRK	4" TF Elbow with Sight Glass and Ext Kit Female Threaded Inlet End - Right Hand
340TFALFL	4" TF Elbow with Sight Glass Female Threaded Inlet End - Left Hand	340TFALFLK	4" TF Elbow with Sight Glass and Ext Kit Female Threaded Inlet End - Left Hand
340TFALA3R	4" TF Elbow with Sight Glass 3" Adapter Inlet End - Right Hand	340TFALA3RK	4" TF Elbow with Sight Glass and Ext Kit 3" Adapter Inlet End - Right Hand
340TFALA3L	4" TF Elbow with Sight Glass 3" Adapter Inlet End - Left Hand	340TFALA3LK	4" TF Elbow with Sight Glass and Ext Kit 3" Adapter Inlet End - Left Hand
340TFALC3R	4" TF Elbow with Sight Glass 3" Coupler Inlet End - Right Hand	340TFALC3RK	4" TF Elbow with Sight Glass and Ext Kit 3" Coupler Inlet End - Right Hand
340TFALC3L	4" TF Elbow with Sight Glass 3" Coupler Inlet End - Left Hand	340TFALC3LK	4" TF Elbow with Sight Glass and Ext Kit 3" Coupler Inlet End - Left Hand



Diagram Reference	Part Number	Description	Assembly
A	340AIEAL99	Inlet End	1
C	—	Shaft	1
D	—	Double Threaded Stud	1
E	340TFFLLAL	Lower Level	1
F	—	Upper Level	1
H	—	Base	1
I	—	Elbow	1
J	—	Cam - Left	1
		Cam - Right	1
K	—	Screws for Inlet End	4
L	340TFSPG	Spring	1
M	—	Flat Washer - Nylon	2
N	—	Slotted Spring Pins	2
O	340TFGF	Grease Fitting	1
P	340PSXX99	Sight Glass	1
Q	40GSKBU97AGM	Gasket @ Sight Glass	2
R	V2.5X109	Fluoroelastomer O-Ring	1
S	—	Hex Nut	1
T	—	Hex Head Cap Screws	4
U	—	Bushing - Plastic	1
V	—	Lock Washer	4
W	340TFTW	Teflon® White Disc	2
X	340GSKBU99	Gasket @ Base	1
Extension Kit			
B	—	Extension Shaft	1
G	—	Base Extension	1
L	340TFSPG	Spring	1
R	V2.5X109	Fluoroelastomer O-Ring	1
T	—	Hex Head Cap Screws	4
V	340TFW	Lock Washer	4

Parts for Tight-Fill Couplings

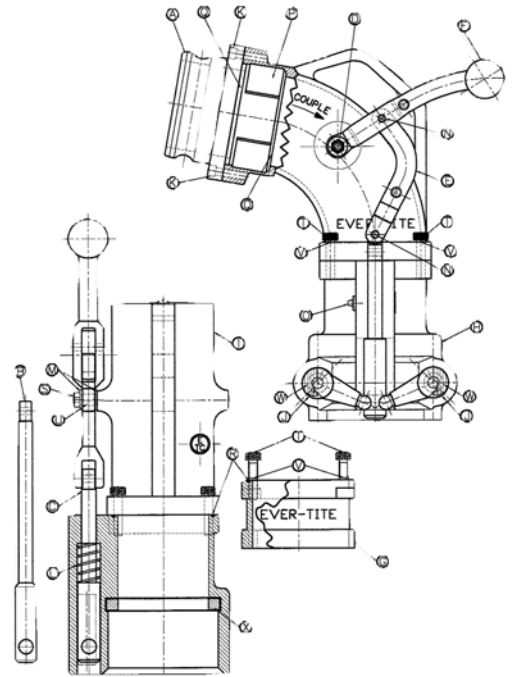



EVER-TITE® ASA Flange Couplings

(A.N.S.I. Class 150)

150 lb flat faced or raised face.



**FLA
Adapter
(Class 150)**



**FLB
Coupler
(Class 150)**

Size	FLA Adapters (Class 150)			FLB Couplers (Class 150)		
	Brass	Aluminum	316 Stainless Steel	Brass	Aluminum	316 Stainless Steel
1"	—	—	310FLASS	—	—	310FLBSS
1-1/2"	315FLABR	315FLAAL	315FLASS	315FLBBR	315FLBAL	315FLBSS
2"	320FLABR	320FLAAL	320FLASS	320FLBBR	320FLBAL	320FLBSS
2"x 2-1/2"	—	—	—	—	—	—
2-1/2"	325FLABR	—	—	—	325FLBAL	—
2-1/2"X 4"	—	—	—	—	—	—
3"	330FLABR	330FLAAL	330FLASS	330FLBBR	330FLBAL	330FLBSS
4"	340FLABR	340FLAAL	340FLASS	340FLBBR	340FLBAL	340FLBSS
4" x 6"	—	—	—	—	—	—
6"	360FLABR	360FLAAL	360FLASS	360FLBBR	360FLBAL	—
8"	—	—	—	—	—	—

EVER-TITE® Railroad Tank Car Adapters



Size	Aluminum
5" X 2"	35020TCAAL
5" X 3"	35030TCAAL
5" X 4"	35040TCAAL

Size	Gaskets	
	Leather	Buna
5"	350GSKLTTC	350GSKBUTC

EVER-TITE® API Gravity Drop Couplings



Size	Aluminum	
	Part Number	Description
4"x3"	340GDCAL30A	4" API Coupler x 3" Adapter
4"x4"	340GDCAL40A	4" API Coupler x 4" Adapter
4"x4"	340GDCAL40B	4" API Coupler x 4" Coupler

API Gravity Drop Coupler Replacement Gasket



Size	Part Number	Description
4"	340GSKBUGDC	4" Buna Gravity Drop Gasket



EVER-TITE®

Aluminum Dust Plug with Bump & Pull Handle



Size	Part Number	Description
4"	340DPALPH	4" Aluminum Dust Plug with bump and pull handle



APG brand worm gear clamps are all 316 Stainless Steel and cost less than competitive brands with carbon steel screws and housings. So what's not to like?

EVER-TITE® 90° coupler w/ check valve



Size	Brass	Aluminum
1-1/2"	315CV90BR	315CV90AL
2"	320CV90BR	320CV90AL
3"	—	330CV90AL

EVER-TITE® Vapor Recovery System



Size	Part Number	Description
3" x 3"	330VRVAL	3" Male adapter with 3" male pipe thread & poppet valve
4" x 4"	340VRVAL	4" Male adapter with 4" female pipe thread & poppet valve
3" x 3"	330VRCAL	3" Female coupler with 3" hose shank & probe
4" x 4"	340VRCAL	4" Female coupler with 4" hose shank & probe
4" x 4"	340VRC90AL	4" Female coupler, 90° elbow, with 4" shank & probe
4" x 3"	34030VRCAL	4" Female coupler with 3" hose shank & probe
4" x 3"	34030VRBAL	4" Female coupler with 3" male pipe thread & probe
4" x 4"	340VRBBAL	4" Female coupler & probe with 4" Female coupler & probe
4" x 3"	34030VRBAAL	4" Female coupler & probe with 3" Male adapter
4" x 3"	34030VRBBAL	4" Female coupler & probe with 3" coupler



Description	Part Number
Large AL Valve Handwheel	3TAVHW2



Description	Part Number
Small AL Valve Handwheel	3TAVHW1

Aluminum Handwheels

EVER-TITE® Fill Pipe Adapters and Caps

Adapter Size	Pipe Size	Part Number
3"	2"	3302097ABR
3"	2-1/2"	—
3"	3"	33097ABR
3"	3"	33097AGBR
3"	4"	—
4"	3"	3403097AGMBR
4"	4"	—
4"	4"	*34097AGMBR
4"	4"	34097AGMCBNL

* NPSM Thread

Brass Only
97A-Adapter Only
97AGM-Adapter (2-1/2" high) with Gasket

Fill-Pipe Adapter



Adapter Cap



Brass Only

Size	Part Number	Description
3"	33097MBR	Locking Cap (Extension Handle)
4"	34097MCB	Locking Cap (Two Handles)
3"	330HBR97M	Locking Handle Only

Also Available are Placard Shields

Protect your placard with APG's Clear Polyethylene PETG plastic. Thicknesses include .020" and .040" made to your specifications.

Tough-TITE® Cam and Groove Couplings



Coupler/Adapter with Relief Nipple

Size Coupler Adapter	Size: Relief Nipple	316 Stainless Steel Part Number
3" x 2"	1/2"	3E3020BASSRN05
3" x 2"	3/4"	3E3020BASSRN07
3" x 2"	1"	3E3020BASSRN10



Spool Adapter with Relief Nipple

Size: Spool Adapter	Size: Relief Nipple	316 Stainless Steel Part Number
3" x 3"	1/2"	3E30SASSRN05
3" x 3"	3/4"	3E30SASSRN07



Spool Coupler with Relief Nipple

Size: Spool Adapter	Size: Relief Nipple	316 Stainless Steel Part Number
2" x 2"	1/2"	3E20BBSSRN05
3" x 3"	1/2"	3E30BBSSRN05

EVER-TITE® Tank Truck Flange Couplings

-TTMA Flanges



LBT Coupler



LAT Adapter

Size	Aluminum	
	LAT Adapter	LBT Coupler
2"	320LATAL	320LBTAL
3"	330LATAL	330LBTAL
4"	340LATAL *340LAT225AL	340LBTAL *340LBT225AL
6"	360LATAL	360LBTAL

* 22-1/2° Elbow

Swing Check Valves with Square Flange

EVER-TITE®



Size	Aluminum	
	Red Silicone Seal	White EPDM Seal
2"	320TCVSFALR	320TCVSFALW
3"	330TCVSFALR	330TCVSFALW





Don't let the pressure get to you! With over 150 different pressure gauges in our inventory, APG can help you and your customers manage the pressure. Dry, liquid filled, black steel or Stainless Steel – they are all on the shelf.

EVER-TITE® Flanges



FLANGE	Size	Aluminum	Plain Steel	Aluminum	Plain Steel	BH Ø	# of holes
Square Flange	2"	320FGSQAL	—	—	—	3.750"	4
	3"	330FGSQAL	—	—	—	4.875"	4
TTMA Round Flange	2"	320TTRFAL	—	—	—	3.750"	8
	3"	330TTRFAL	—	—	—	4.875"	8
	4"	340TTRFAL	—	—	—	5.875"	8
TTMA Flued Flange	Flued		Blind Flued				
	2"	—	320TTFLPS	—	—	3.750"	6
	3"	330TTFLAL	330TTFLPS	—	330TTLBPS	4.875"	8
	4"	340TTFLAL	340TTFLPS	—	340TTLBPS	5.875"	8
TTMA Flange X NPT Thread	FEMALE NPT		Male NPT				
	3"	330TTFALF	330TTFPSF	330TTFALM	330TTFPSM	4.875"	8
	4"	340TTFALF	—	340TTFALM	—	5.875"	8



Fabricated Gaskets for Transportation

Size	Non-Abestos	Cork/ Rubber	Green Fluoroelastomer	PTFE Envelope w/Non-Asbestos Filler
TTMA Flange Gasket - 1/8" Thick				
2"	13TT15201GSKNA	13TT15201GSKCB	—	—
3"	13TT15313GSKNA	13TT15313GSKCB	13TT15313GSKGVT	13TT15313TFEVCUT-NA
4"	13TT15317GSKNA	13TT15317GSKCB	13TT15317GSKGVT	13TT15317TFEVCUT-NA
6"	13TT15601GSKNA	13TT15601GSKCB	—	—
TTMA Drain Sump Gasket - 1/8" Thick				
3"	13TT15181GSKNA	13TT15181GSKCB	—	—
4"	13TT15266GSKNA	13TT15266GSKCB	13TT15266GSKGVT	13TT15266TFEVCUT-NA
Tank Truck Square Flange Gasket - 1/8" Thick				
2"	13TTMA200SQNA	13TTMA200SQCB	—	—
3"	13TTMA300SQNA	13TTMA300SQCB	—	—

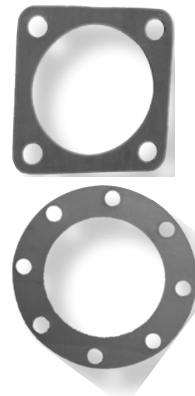

Dome Lid/Manhole Seals

Size	Dome Lid Packing	
5/8" X 68"	113000	Acrylic fiber with PTFE - Dry
5/8" X 68"	113000L	Acrylic Fiber with PTFE - Lubricated
Round Dome Lid Gaskets		
20"	13TT3513VT	Black Fluoroelastomer
20"	13TT3513BN	Black Nitrile/Buna
20"	13TT3513WH	White Hypalon
20"	13TT3513NEO	White Neoprene
20"	13TT3513WB	White Nitrile/Buna
20"	13TT3513EP	Black EPDM
L Shaped Dome Lid Gaskets		
16"	13TT3559BN	Black Nitrile/Buna
20"	13TT3560BN	Black Nitrile/Buna



External Valve Bonnett Gasket

Size	EPDM - 1/8" Thick
3	13TT15905EP
4	13TT15977EP

Valve Seat

PTFE	
13TF15202VST	0.5" Thick X 2.58" ID X 3.937" OD

CrimPro Professionals

Crimping

Why Crimp?

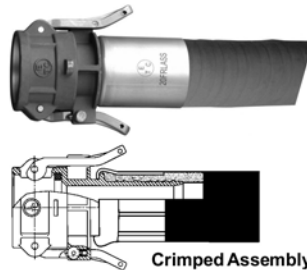

Crimped hose connections provide a more reliable and safer alternative to banding. Banding Buckles can be a risk of injury to the operator handling the hose assembly.

- APG/EVER-TITE® crimp sleeves are seamless for increased strength and reliability.
- The non-sparking aluminum crimp sleeves and ferrules provide an additional safety feature to the assembly.
- Escape the liability that band attachments provide with a “smooth” connection.
- Boost your shank retention with APG/EVER-TITE® interlocking ferrules. Designed for critical applications. These ferrules can be crimped or swaged.

Ask about the APG/EVER-TITE® CrimPro Calculator to assist in computing the OD crimp target.

- EVER-TITE® Stainless Steel ferrules are designed to meet the greater retention requirements of XLPE and UHMW chemical transfer hoses.
- Tested to meet or exceed the Rubber Manufacturers Association liquid hose pressure safety requirements of four (4) times the working pressure without leaking.
- Reference the NAHAD Hose Assembly Guidelines for industry standard recommendations and requirements associated with fabrication and testing of hose assemblies.

Note: APG/EVER-TITE® coupling products, ferrules and crimp sleeves should be used only in combination with one another. Different brands of these type products are not interchangeable in any combination.

Strengthen your industrial hose connection with APG/EVER-TITE® crimp sleeves and notched ferrules. APG/EVER-TITE® industrial hose couplings are the connection solution for demanding applications.



“America’s Most Responsive Warehouse”

MARKENTM Crimping Machines

MANUFACTURING

Efficiently create hose assemblies for a variety of industrial applications. The addition of a crimp machine to any shop can benefit production.

- + Cut cost and increase production
- + Crimping force up to 440 tons
- + Touch screen display and controls



K40

Size	Max Crimp size
2" Industrial	3" (76 mm)



K60

Size	Max Crimp size
4" Industrial	5.5" (130 mm)



K285

Size	Max Crimp size
6" 150lb Flange	9" (230 mm) (Min. 1/4")

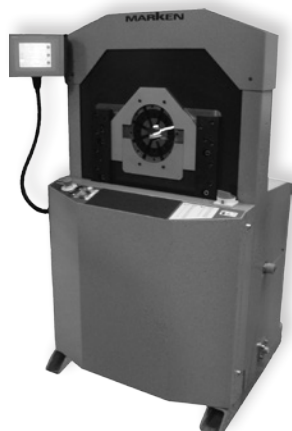

KP300

Size	Max Crimp size
4" Industrial	5.5" (130 mm)



KP400

Size	Max Crimp size
10" Industrial	ANSI 150 6" 1/34" (300mm)



EVER-TITE® CrimPro Sleeves & Ferrules



Note: Aluminum Crimp Sleeves Can Be Anodized In Various Colors

Size	Notched Ferrule	Multi-Notched Ferrule	Crimp Sleeve		Hose Dim. (Inches)		Crimp Sleeve Dim. (Inches)		
	304 Stainless Steel	Aluminum	304 Stainless Steel	Aluminum	OD Min.	OD Max.	Thickness	ID	Length
3/4"	307FRLASS	—	307CRLASS	—	1-2/64	1-8/64	0.065	1.150	1.850
	307FRLBSS	—	307CRSASS	307CRSAAL	1-2/64	1-8/64	0.065	1.150	1.500
	—	—	307CRSBSS	307CRSBAL	1-6/64	1-15/64	0.065	1.300	1.500
1"	310FRLASS	—	310CRSASS	310CRSAAL	1-29/64	1-35/64	0.065	1.620	1.750
	310FRLBSS	—	310CRSBSS	310CRSBAL	1-36/64	1-44/64	0.065	1.770	1.750
	—	—	—	310CRSCAL	1-42/64	1-50/64	0.065	1.8700	2.000
1-1/4"	—	—	312CRSASS	312CRSAAL	1-39/64	1-60/64	0.065	2.000	2.000
1-1/2"	315FRLASS	315FRLAALN	315CRSASS	315CRSAAL	1-60/64	2-12/64	0.083	2.334	2.000
	315FRLBSS	—	315CRSBSS	—	2-4/64	2-22/64	0.065	2.370	2.000
	—	—	—	315CRSCAL	2-20/64	2-26/64	0.083	2.450	2.000
2"	—	—	320CRSAASS	—	2-26/64	2-34/64	0.083	2.560	2.250
	320FRLASS	320FRLAALN	320CRSASS	320CRSAAL	2-30/64	2-44/64	0.083	2.709	2.250
	320FRLBSS	320FRLBALN	320CRSBSS	320CRSBAL	2-42/64	2-54/64	0.120	2.885	2.250
	—	320FRLCALN	—	320CRSCAL	2-50/64	3	0.120	3.085	2.250
2-1/2"	—	—	325CRSASS	325CRSAAL	2-62/64	3-14/64	0.120	3.260	2.750
	325FRLBSS	—	325CRSBSS	—	3-13/64	3-22/64	0.120	3.385	2.750
	—	—	—	325CRSCAL	3-16/64	3-31/64	0.120	3.510	3.000
3"	330FRLASS	330FRLAALN	330CRSASS	330CRSAAL	3-30/64	3-46/64	0.120	3.760	3.000
	330FRLBSS	330FRLBALN	330CRSBSS	330CRSBAL	3-47/64	3-54/64	0.120	3.885	3.000
	—	330FRLCALN	—	330CRSCAL	3-56/64	4	0.120	4.010	3.000
	—	—	—	330CRSDAL	4	4-16/64	0.120	4.375	3.000
4"	340FRLASS	340FRLAALN	340CRSASS	340CRSAAL	4-40/64	4-47/64	0.120	4.760	3.000
	340FRLBSS	340FRLBALN	340CRSBSS	340CRSBAL	4-48/64	4-56/64	0.120	5.010	3.000
5"	—	—	—	350CRSAAL	5-16/64	5-32/64	0.120	5.400	4.450
6"	—	—	—	360CRSAAL	6-16/64	6-48/64	0.155	6.750	5.000
	—	*360FRLPS*	—	360CRSBAL	6-31/64	7-12/64	0.175	7.250	5.000
8"	—	—	—	380CRSAAL4	8-20/64	8-60/64	0.175	9.100	4.000
	—	—	—	380CRSAAL6	8-20/64	8-60/64	0.175	9.100	6.000
	—	—	—	380CRSBAL4	8-60/64	9-32/64	0.175	9.750	4.000
	—	—	—	380CRSBAL6	8-60/64	9-32/64	0.175	9.750	6.000
	—	—	380CRSACS	—	8-20/64	8-60/64	0.125	9.100	4.000
	—	—	380CRSBCS	—	8-60/64	9-32/64	0.125	9.750	4.000

• APG/EVER-TITE® Multi-Notched Ferrules 1-1/2" - 4" are compatible with EVER-TITE® 1-1/2"-4" Aluminum cam and groove coupling parts with round shoulder hose shanks.

• 360FRLPS is compatible with the 4-handle part "C" (360CAL4S) and part "E" (360EALS) with round ferrule shoulder on page 29.

• APG/EVER-TITE® Crimp Sleeves are compatible with EVER-TITE®, Tough-TITE®, and U-TITE® Stainless Steel, Aluminum and Brass cam and coupling parts with hose shanks.

See page 4 for cam & groove part C. See Page 6 for cam & groove part E.

See page 10 for locking handle couplers.

Note:

APG/EVER-TITE® coupling products, ferrules and crimp sleeves should be used only in combination with one another. Different brands of these type products are not interchangeable in any combination.



When many people think of APG EVER-TITE® couplings, they think “Cam and Groove Couplings.” And this is great, because they are the best cam and groove values on the market. But don’t forget all the other products in our Industrial Hose Coupling Catalog.

EVER-TITE® CrimPro Cam & Groove Couplings

CrimPro Combination Nipples

- with shoulder for APG multi-notched aluminum ferrules

Size	Steel Plated
1-1/2"	3TCNPG150
2"	3TCNPG200
3"	3TCNPG300
4"	3TCNPG400
6"	3TCNPG600



PART C 4 Handle Coupler

- with shoulder for multi-notched ferrules

Size	Aluminum
4"	340CAL4S
6"	360CAL4S



PART E Adapter

- with shoulder for multi-notched ferrules

Size	Aluminum
6"	360EALS



Size	EVER-TITE®	Tough-TITE®
	316 Stainless Steel	316 Stainless Steel
	Hose Shank x Male Thread With Notched Collar	Hose Shank x Male Thread With Notched Collar And Wrench Flat
3/4	—	3E07CNSSN
1	—	3E10CNSSN
1-1/2	—	3E15CNSSN
2	—	3E20CNSSN
3	330CNSS	—
4	340CNSS	—

Hose Shank x Male Thread



EVER-TITE®



Tough-TITE®

* 3/4" parts compatible with additional machining of standard parts

Swivel-TITE®

- Less torque on the hose extends hose life hose assemblies with permanently
- Easier connection in limited space attached couplings environments
- Eliminate operator torque
- Patent Nos. 5,947, 530 and 5,944, 364

Part C Swivel Coupler	
Size	316 Stainless Steel
2"	320CSSSWVL
3"	330CSSSWVL
4"	340CSSSWVL



Combination Nipples and Menders

Combination Nipple

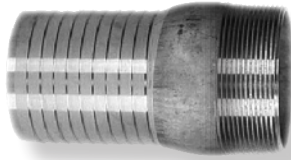

Size	Steel-Plain	Steel-Plated	316 Stainless Steel	Brass	Aluminum	Polypropylene	PSI
1/2"	3TCNS0050	3TCNP0050	3TCNSS050	3TCNB050	3TCNA050	3TCNPY050	125
3/4"	3TCNS0075	3TCNP0075	3TCNSS075	3TCNB075	3TCNA075	3TCNPY075	125
1"	3TCNS0100	3TCNP0100	3TCNSS100	3TCNB100	3TCNA100	3TCNPY100	125
1-1/4"	3TCNS0125	3TCNP0125	3TCNSS125	3TCNB125	3TCNA125	3TCNPY125	125
1-1/2"	3TCNS0150	3TCNP0150	3TCNSS150	3TCNB150	3TCNA150	3TCNPY150	125
2"	3TCNS0200	3TCNP0200	3TCNSS200	3TCNB200	3TCNA200	3TCNPY200	125
2-1/2"	3TCNS0250	3TCNP0250	3TCNSS250	3TCNB250	3TCNA250	—	75
3"	3TCNS0300	3TCNP0300	3TCNSS300	3TCNB300	3TCNA300	3TCNPY300	75
4"	3TCNS0400	3TCNP0400	3TCNSS400	3TCNB400	3TCNA400	3TCNPY400	50
5"	3TCNS0500	3TCNP0500	3TCNSS500	—	—	—	25
6"	3TCNS0600	3TCNP0600	3TCNSS600	—	—	—	25
8"	3TCNS0800	3TCNP0800	—	—	—	—	—
10"	3TCNS1000	3TCNP1000	—	—	—	—	—
12"	3TCNS1200	3TCNP1200	—	—	—	—	—

Note: See Combination Nipples for Multi-Notched Ferrules on page 29.

Combination Nipple Grooved End (Plain Steel)

- with pipe groove

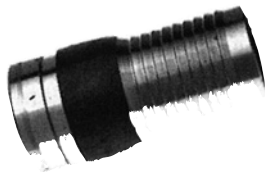

Size	Part Number
1/2"	—
3/4"	—
1"	3TCNV0100
1-1/4"	3TCNV0125
1-1/2"	3TCNV0150
2"	3TCNV0200
2-1/2"	3TCNV0250
3"	3TCNV0300
4"	3TCNV0400
5"	3TCNV0500
6"	3TCNV0600
8"	3TCNV0800
10"	3TCNV1000

Hose Mender (Plated Steel)



Size	Part Number
3/8"	3TMP037
1/2"	3TMP050
3/4"	3TMP075
1"	3TMP100
1-1/4"	3TMP125
1-1/2"	3TMP150
2"	3TMP200
2-1/2"	3TMP250
3"	3TMP300
4"	3TMP400
5"	3TMP500
6"	3TMP600
8"	3TMP800
10"	3TMP1000

Jump Combination Nipple (Plated Steel)



Size	Part Number
1-1/4 x 1"	3TCNP01250100
1-1/4" x 1-1/2"	3TCNP01250150
1-1/2" x 2"	3TCNP01500200
2" x 1-1/2"	3TCNP02000150

Combination Nipple Beveled Welded End (Plain Steel)



Size	Part Number
1/2"	—
3/4"	3TCNW075
1"	3TCNW100
1-1/4"	3TCNW125
1-1/2"	3TCNW150
2"	3TCNW200
2-1/2"	3TCNW250
3"	3TCNW300
4"	3TCNW400
5"	3TCNW500
6"	3TCNW600

Hose Mender Extended Length



Size	Part Number
1-1/4"	3TMPKM102



Don't forget – APG has a large selection of Brass Hydrant Adapters and Hex Nipples – including the very popular Swivel Adapters. All on the shelf, ready for same or next day shipment.

Sand Blast Couplings

Hose I.D.	Hose O.D.	Aluminum	Brass
3/4"	1-1/2"	3TQ1A	3TQ1B
1"	1-7/8"	3TQ2A	3TQ2B
1-1/4"	2-5/32"	3TQ3A	3TQ3B
1-1/2"	2-3/8"	3TQ4A	3TQ4B

Hose I.D.	Hose O.D.	Thread Size & Type (Inches)	Aluminum	Brass
3/4"	1-1/2"	1-1/4NPS	3TNH1A	3TNH1B
1"	1-7/8"	1-1/4NPS	3TNH2A	3TNH2B
1-1/4"	2-5/32"	1-1/4NPS	3TNH3A	3TNH3B
1-1/2"	2-3/8"	1-1/4NPS	3TNH4A	3TNH4B

Thread Size & Type (Inches)	Aluminum	Brass
1-1/4NPT	3TSB1A	3TSB1B
1-1/2NPT	3TSB2A	3TSB2B

Part Q Hose End



Part NH Nozzle Holder

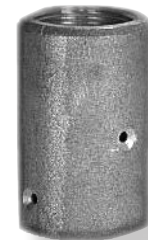

Part SB Adapter



NBR Gasket

(One Size Fits All)

Part Number
3TSBG



Screws

Part Number
3TSBS

Replacement Sandblast Lenses

Replacement lenses and visors have been tested and stamped for CSA and ANSI approval insuring conformity. Most sizes are available with Polyfilm or Tissue Interleave. Tinted lenses are available upon request. Assorted lenses can be combined to obtain quantity breaks. Lenses available for the following helmets:

- ▶ Bullard 77 & 88 Series New 88 VX
- ▶ Bullard 46 Series
- ▶ Bullard 20 Series
- ▶ Bullard BH-5 Safe-T-Site
- ▶ Clemco Apollo 20
- ▶ Clemco Apollo 50
- ▶ Clemco Apollo 60
- ▶ Clemco Apollo 600
- ▶ Clemco Apollo 20
- ▶ NorthStar ASH-301
- ▶ NorthStar ASH-960
- ▶ Nova 2000
- ▶ Nova Astro
- ▶ 3M W-5006
- ▶ 3M W-8100 & W-8100



CALL US



EMAIL



FAX



WALK-IN

"AMERICA'S MOST RESPONSIVE WAREHOUSE"

Accessories

Handle Assembly

Handle, Ring, and Pin



EVER-TITE®



Tough-TITE®



U-TITE®



EVER-TITE®
Paddle Handle (Handle Only)

Size	Tough-TITE®		U-TITE®		
	Brass	316 Stainless Steel	Brass	316 Stainless Steel	316 Stainless Steel
1/2" , 3/4"	307HRPBR	307HRPSS	3E07HRPBR	3E07HRPSS	—
1"	310HRPBR	310HRPSS	3E10HRPBR	3E10HRPSS	—
1-1/4" - 2-1/2"	315HRPBR	315HRPSS	3E15HRPBR	3E15HRPSS	3U15HRPBR 3U15HRPSS
3" , 4" , 5"	330HRPBR	330HRPSS	3E30HRPBR	3E30HRPSS	3U30HRPBR 3U30HRPSS
6"	360HRPBR	360HRPSS	3E60HRPBR	3E60HRPSS	—
8"	380HRPBR	380HRPSS	*	*	—

* 8" Tough-Tite® couplers Employ 6" handles

Stainless Steel Pin



Size	Part No.
3/4-1"	—
1-1/4-2-1/2"	3WP200
3-5"	3WP300
6"	3WP600
8"	3WP800

Ring



2-Turn 3-Turn

Size	Turns	Steel Plated	Stainless Steel
		3/4"-2-1/2"	2
3"-8"	3	3LRXXO	3LRSSO

Safety Clip



Size	Part No.
3/4-1"	3WLC
1-1/4-2-1/2"	3WLC
3-5"	3WLC
6-8"	3WLC6

Chain with "S" Hooks

Size	Brass	316 Stainless Steel
	6"	360CHBR
12"	3120CHBR	3120CHSS



Safety Cables

Hose End to Hose End



Cable	Hose I.D.	Length	Part Number
1/8"	1/2"-1-1/4"	20"	3TWHH1
1/4"	1-1/2"-3"	38"	3TWHH2

Hose End to Tool End



Cable	Hose I.D.	Length	Part Number
1/8"	1/2"-1-1/4"	20"	3TWHT1
1/4"	1-1/2"-3"	38"	3TWHT2



Need brass swing check valves? They are on the shelf at APG in seven sizes from 1/2" through 3" inch – ready for same or next day shipment.

EVER-TITE® Cam & Groove Gaskets

Dimensions

Size	Buna Lathe Cut (Mil/Spec)	Buna Lathe Cut Extra Thick	Gum Lathe Cut	EPDM
1/2"	*305GSKBU	—	—	305GSKEP
3/4"	307GSKBUMS	—	—	307GSKEP
1"	310GSKBUMS	310GSKBUX	310GSKGM	310GSKEP
1-1/4"	312GSKBUMS	312GSKBUX	—	312GSKEP
1-1/2"	315GSKBUMS	315GSKBUX	315GSKGM	315GSKEP
2"	320GSKBUMS	320GSKBUX	320GSKGM	320GSKEP
2-1/2"	325GSKBUMS	325GSKBUX	—	325GSKEP
3"	330GSKBUMS	330GSKBUX	330GSKGM	330GSKEP
4"	340GSKBUMS	340GSKBUX	340GSKGM	340GSKEP
5"	*350GSKBU	—	350GSKGM	350GSKEP
6"	360GSKBUMS	360GSKBUX	360GSKGM	360GSKEP
8"	*380GSKBU	—	—	—

Size	Outside Diameter	Inside Diameter	Thickness
1/2"	1.031	0.687	0.156
3/4"	1.375	0.875	0.216
1"	1.562	1.062	0.250
1-1/4"	1.968	1.375	0.250
1-1/2"	2.218	1.625	0.250
2"	2.656	2.000	0.250
2-1/2"	3.156	2.375	0.250
3"	3.750	3.000	0.250
4"	4.875	4.000	0.250
5"	6.000	5.062	0.250
6"	7.093	6.000	0.250
8"	9.500	8.062	0.375

* No Mil/Spec for 1/2", 5", and 8"

Size	Neoprene Lathe Cut Black	Neoprene Lathe Cut White	Fluoroelastomer Lathe Cut	Green Fluoroelastomer	Butyl Lathe Cut	Silicon Lathe Cut	PTFE Envelope	
							Buna	Fluoroelastomer
1/2"	305GSKNB	305GSKNW	305GSKVA	—	305GSKBT	305GSKSI	305GSKTB	305GSKTV
3/4"	307GSKNB	307GSKNW	307GSKVA	—	307GSKBT	307GSKSI	307GSKTB	307GSKTV
1"	310GSKNB	310GSKNW	310GSKVA	—	310GSKBT	310GSKSI	310GSKTB	310GSKTV
1-1/4"	312GSKNB	312GSKNW	312GSKVA	—	312GSKBT	312GSKSI	312GSKTB	312GSKTV
1-1/2"	315GSKNB	315GSKNW	315GSKVA	—	315GSKBT	315GSKSI	315GSKTB	315GSKTV
2"	320GSKNB	320GSKNW	320GSKVA	320GSKVAG	320GSKBT	320GSKSI	320GSKTB	320GSKTV
2-1/2"	325GSKNB	325GSKNW	325GSKVA	—	325GSKBT	325GSKSI	325GSKTB	325GSKTV
3"	330GSKNB	330GSKNW	330GSKVA	330GSKVAG	330GSKBT	330GSKSI	330GSKTB	330GSKTV
4"	340GSKNB	340GSKNW	340GSKVA	340GSKVAG	340GSKBT	340GSKSI	340GSKTB	340GSKTV
5"	350GSKNB	350GSKNW	350GSKVA	—	350GSKBT	350GSKSI	350GSKTB	350GSKTV
6"	360GSKNB	360GSKNW	360GSKVA	—	360GSKBT	360GSKSI	360GSKTB	360GSKTV
8"	—	—	—	—	—	—	—	—

Cam & Groove Gasket Material Identification

Gasket Material	Color Code Marking on Gasket
Buna-N	Blue stripe on O.D.
Buna-N (Mil/Spec)	Blue stripe/white stripe on O.D.
Neoprene	Red stripe on O.D.
EPDM	Double white stripe on O.D.
Gum	No marking
Butyl	White Stripe on O.D.
Fluoroelastomer	Yellow Stripe on O.D.
Silicone	Red Gasket
Green Fluoroelastomer	Green Gasket

Buna Fuel Gaskets

Long lasting resistance to ethanol blend fuel

Size	Buna Lathe Cut
1"	310GSKBUF
1-1/2"	315GSKBUF
2"	320GSKBUF
2-1/2"	325GSKBUF
3"	330GSKBUF
4"	340GSKBUF
5"	350GSKBUF



Pipe Coupling Gaskets

For Use with grooved pipe fittings

Size	Buna - N
1-1/2"	3VCBU150
2"	3VCBU200
2-1/2"	3VCBU250
3"	3VCBU300
3"	3VCBU300ES
4"	3VCBU400
4-1/2"	3VCBU450
5"	3VCBU500
6"	3VCBU600
8"	3VCBU800

Hammer Union Seals

Size	Highly Saturated Nitrile	NBR-Nitrile	NBR-Nitrile with Brass Ring	FKM Fluorelastomer	FKM Fluorelastomer with Brass Ring	FKM Fluorelastomer With Stainless Steel Ring
1"	3HUSHS010 [◇]	3HUSN010 [◇]	—	3HUSV010 [◇]	—	—
1-1/2"	3HUSHS015 [◇]	3HUSN015 [◇]	—	3HUSV015 [◇]	—	—
2"	3HUSHS020	3HUSN020*	3HUSN020B	3HUSV020***	3HUSV020B	3HUSV020SS
3"	3HUSHS030	3HUSN030*	3HUSN030B	3HUSV030**	—	3HUSV030SS
4"	3HUSHS040	3HUSN040	—	3HUSV040**	—	3HUSV040SS

*Available with brass ring

**Available with a Stainless Steel ring

[◇] Available in a thicker material

Sanitary Gaskets

- For Use in processing pipeline systems in the food, Beverage, and Pharmaceutical Industries
- FDA Compliant

Standard Clamp Gaskets

Material	PTFE "G"	FKM "SFY"	NBR "U"	NBR "UW"	Silicone "X"	EPDM "E"
Color	White	Black	Black	White	Red	Black
1"	3Y40MPG100	3Y40MPSFY100	3Y40MPU100	3Y40MPUW100	3Y40MPX100	3Y40MPE100
1-1/2"	3Y40MPG150	3Y40MPSFY150	3Y40MPU150	3Y40MPUW150	3Y40MPX150	3Y40MPE150
2"	3Y40MPG200	3Y40MPSFY200	3Y40MPU200	3Y40MPUW200	3Y40MPX200	3Y40MPE200
2-1/2"	3Y40MPG250	3Y40MPSFY250	3Y40MPU250	3Y40MPUW250	3Y40MPX250	3Y40MPE250
3"	3Y40MPG300	3Y40MPSFY300	3Y40MPU300	3Y40MPUW300	3Y40MPX300	3Y40MPE300
4"	3Y40MPG400	3Y40MPSFY400	3Y40MPU400	3Y40MPUW400	3Y40MPX400	3Y40MPE400

Mesh Mini Clamp Gaskets

Size	Highly Saturated Nitrile	NBR-Nitrile
1/2"	3Y42MPU050	3Y42MPE050
3/4"	3Y42MPU075	3Y42MPE075

Also available are FDA compliant O-rings

- EPR 70 NSF61
- Fluoroelastomer White 60 Durometer
- Nitrile White 70 Durometer
- Silicone 70 Durometer
- Fluoroelastomer Metal Detectable 75 Durometer
- Nitrile Metal Detectable 70 Durometer
- Silicone Metal Detectable 70 Durometer

Size	Part Number
1-1/2	3TFV150
2	3TFV200
2-1/2	3TFV250
3	3TFV300
4	3TFV400
6	3TFV600
8	3TFV800



Foot Valves

Galvanized Iron Foot Valve

-with rubber weight

Foot Valve Repair Parts

Strainer



Size	Part Number
1-1/2"	3TSTR150
2"	3TSTR200
2-1/2"	3TSTR250
3"	3TSTR300
4"	3TSTR400
6"	3TSTR600
8"	—

Size	Part Number
1-1/2"	3TLWWS150
2"	3TLWWS200
2-1/2"	3TLWWS250
3"	3TLWWS300
4"	3TLWWS400
6"	3TLWWS600
8"	3TLWWS800

Leather Weight Washer and Screw

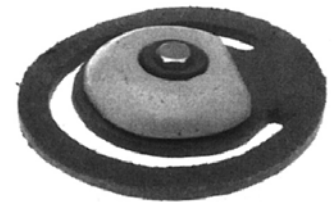

Leather

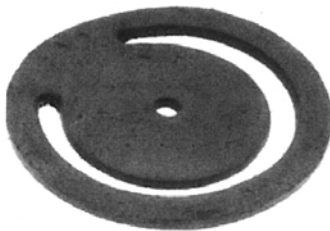

Size	Part Number
1-1/2"	3TLEA150
2"	3TLEA200
2-1/2"	3TLEA250
3"	3TLEA300
4"	3TLEA400
6"	3TLEA600
8"	3TLEA800

Size	Part Number
1-1/2"	3TSP150
2"	3TSP200
2-1/2"	3TSP250
3"	3TSP300
4"	3TSP400
6"	3TSP600
8"	3TSP800

Seat Plate

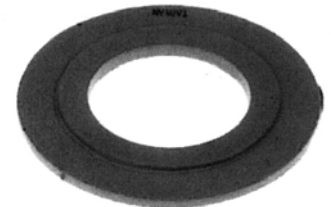

Strainers (Steel)

Round Hole



Size	Part Number
1-1/2"	3TRHS150
2"	3TRHS200
2-1/2"	3TRHS250
3"	3TRHS300
4"	3TRHS400
6"	3TRHS600
8"	3TRHS800

Size	Part Number
1-1/2"	3TSHS150
2"	3TSHS200
3"	3TSHS300
4"	3TSHS400
6"	3TSHS600

Square Hole



Top Hole



Size	Part Number
1-1/2"	3TTHS150
2"	3TTHS200
3"	3TTHS300

Size	Part Number
1-1/2"	3TBHS150
2"	3TBHS200
3"	3TBHS300

Bottom Hole

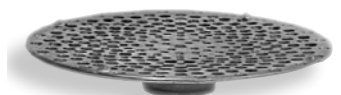



Universal Crowfoot Couplings

150 PSI



Part HE

Hose End

Size	Low Carbon Steel	Brass	Stainless Steel
3/8"	3THE037C	3THE037B	—
1/2"	3THE050C	3THE050B	3THE050SS
3/4"	3THE075C	3THE075B	3THE075SS
1"	3THE100C	3THE100B	3THE100SS



Part FE

Female NPT

Size	Low Carbon Steel	Brass	Stainless Steel
1/4"	3TFE025C	—	—
3/8"	3TFE037C	3TFE037B	—
1/2"	3TFE050C	3TFE050B	3TFE050SS
3/4"	3TFE075C	3TFE075B	3TFE075SS
1"	3TFE100C	3TFE100B	3TFE100SS



Part ME

Male NPT

Size	Low Carbon Steel	Brass	Stainless Steel
1/4"	3TME025C	—	—
3/8"	3TME037C	3TME037B	—
1/2"	3TME050C	3TME050B	3TME050SS
3/4"	3TME075C	3TME075B	3TME075SS
1"	3TME100C	3TME100B	3TME100SS



Dead End

Low Carbon Steel	Stainless Steel
3TDE301C	3TDESS



Part TE

3-Way Connector

Low Carbon Steel	Brass
3TTE300C	3TTE300B



Part HE

4-Lug Hose End

Size	Low Carbon Steel
1-1/4"	3THE125C
1-1/2"	3THE150C
2"	3THE200C

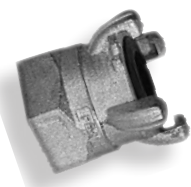

Part FE

4-Lug Female NPT

Size	Low Carbon Steel
1-1/4"	3TFE125C
1-1/2"	3TFE150C
2"	3TFE200C



Need brass swing check valves? They are on the shelf at APG in seven sizes from 1/2" through 3" inch – ready for same or next day shipment.

Universal Crowfoot Couplings - Accessories

	Part No.
Lanyard	3TCFL
Safety Clip	3TCFC

Lanyard and Safety Clip



Replacement Gaskets - NBR

	Part No.
For 2-Lug	3TRG2
For 4-Lug	3TRG4



The use of a Universal Crowfoot Safety Clip retainer is necessary to assure Universal Crowfoot Couplings will not become accidentally disconnected. This ensures the fittings are properly connected as the pin will not go through holes in mating glances until couplings are fully locked in place.

Coupled Red Air Hose

Part #	Description
307CAHX50	Coupled Red Air Hose 3/4" X 50' Max Pressure: 150 PSI



-3/4" Zinc Steel Plated Crowfoot crimped to each end of the hose.

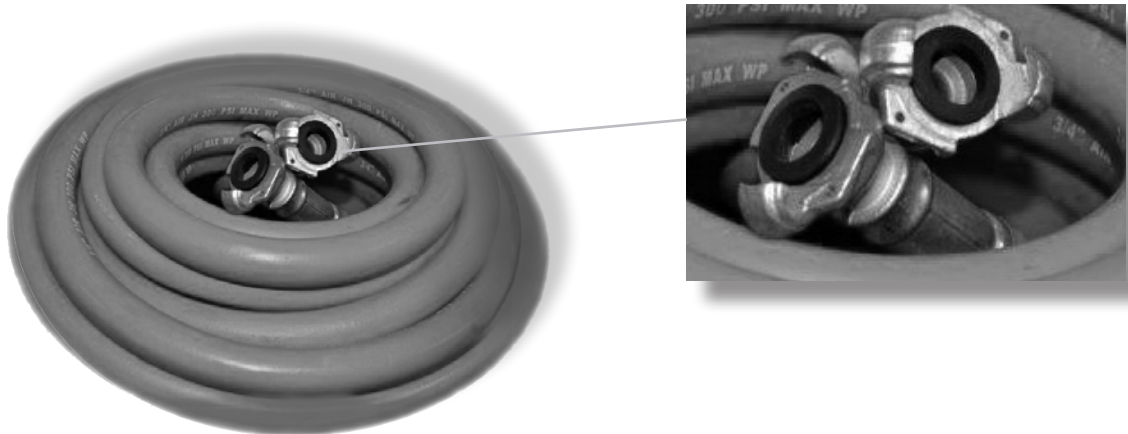

Hydrant Adapters - Brass



Size/Description	Part Number
1-1/2" Female NST x 3/4" Male GHT	3TGHA1576
2-1/2" Female NST x 3/4" Male GHT	3TGHA2576
2-1/2" Female NST x 1" Male NPSH	3THHA2510
2-1/2" Female NST x 1-1/2" Male NPSH	3THHA2515
2-1/2" Female NST x 2" Male NPSH	3THHA2520
2-1/2" Female NST x 1-1/2" Male NST	3TNHA2515F
3" Female NST x 2-1/2" Male NST	3TNHA3025F
2-1/2" Female NST x 3/4" Male NPT	3TPHA2575T
2-1/2" Female NST x 1" Male NPT	3TPHA2510T
2-1/2" Female NST x 1-1/2" Male NPT	3TPHA2515T
2-1/2" Female NST x 2" Male NPT	3TPHA2520T
3" Female NPSH x 2-1/2" Male NST	3TSHS3025T

Hex Nipples - Brass



Female x Male



Male x Male

Size/Description	Part Number
1" Female NPT x 3/4" Male GHT	3TFGFM1076
1-1/2" Female NPT x 1-1/2" Male NPSH	3TMHFM1515
2-1/2" Female NPT x 2-1/2" Male NPSH	3TMHFM2525
1-1/2" Female NPT x 1-1/2" Male NST	3TFNFM1515F
2-1/2" Female NPT x 2-1/2" Male NST	3TFNFM2525F
3" Female NPT x 2-1/2" Male NST	3TFNFM3025F
1" Female NPSH x 3/4" Male GHT	3TFGFM10S76
1-1/2" Female NPSH x 1-1/2" Male NST	3TFNFM15S15F
3/4" Female GHT x 1" Male NPT	3TFPFM7610T
1-1/2" Female NST x 1-1/2" Male NPT	3TFPFM15F15T
2-1/2" Female NST x 2-1/2" Male NPT	3TFPFM25F25T
2-1/2" Female Phoenix x 2-1/2" Male NPT	3THNPHX2525
1" Male NPT x 3/4" Male GHT	3TMGDMH1076
1" Male NPT x 1" Male NPSH	3TMHDMH1010
1-1/2" Male NPT x 1-1/2" Male NPSH	3TMHDMH1515
2-1/2" Male NPT x 2-1/2" Male NPSH	3TMHDMH2525
1" Male NPT x 1" Male NST	3TMNDMH1010F
1-1/2" Male NPT x 1-1/2" Male NST	3TMNDMH1515F
2" Male NPT x 2-1/2" Male NST	3TMNDMH2025F
2-1/2" Male NPT x 2-1/2" NST	3TMNDMH2525F
3" Male NPT x 2-1/2" Male NST	3TMNDMH3025F
1-1/2" Male NST x 1-1/2" Male NST	3TMNDMH15F15F

Swivel Adapters-Brass



Female x Male



Female x Female

Size/Description	Part Number
1-1/2" Female NST x 1-1/2" Male NPT	3TSM15X15
2-1/2" Female NST x 1-1/2" Male NPT	3TSM25X15
2-1/2" Female NST x 2" Male NPT	3TSM25X20
2-1/2" Female NST x 2-1/2" Male NPT	3TSM25X25
2-1/2" Female NST x 3" Male NPT	3TSM25X30
1-1/2" Female NST x 1-1/2" Female NPT	3TSF15X15
2-1/2" Female NST x 1-1/2" Female NPT	3TSF25X15
2-1/2" Female NST x 2" Female NPT	3TSF25X20
2-1/2" Female NST x 2-1/2" Female NPT	3TSF25X25
2-1/2" Female NST x 3" Female NPT	3TSF25X30



When many people think of APG EVER-TITE® couplings, they think “Cam and Groove Couplings.” And this is great, because they are the best cam and groove valves on the market. But don't forget all the other products in our Industrial Hose Coupling Catalog.

Hydrant Adapter - Reducer

Size	Malleable Iron Part Number
3 x 2"	3TR3020D



Adjustable Hydrant Wrench

For use with external valves

Description	Part Number
Adjustable Hydrant Wrench	3TW189



EVER-TITE® Fire Hose Couplings

- NH Standard thread
- Used for connecting fire and forestry hoses to fire hydrants.



Part A



Part B



Part D





Part F

Size	Aluminum				Replacement Gasket
	Part A	Part B	Part D	Part F	Buna Lathe Cut
1-1/2"	315AALNH	-	315DALNH	315FALNH	315GSKBUNH
2-1/2"	325AALNH	325BALNH	325DALNH	325FALNH	325GSKBUNH
3" x 2-1/2"	-	-	33025DALNH	-	

Long Shank Hose Couplings

Brass, Steel-Plated, Ductile Iron-Plated

Part Description	Hose I.D.	Brass		Steel-Plated/Ductile Iron-Plated	
		Thread Size and Type (Inches)	Part Number	Thread Size and Type (Inches)	Part Number
 Complete Set	3/8"	3/4 GHT	—	3/8 NPSM	—
	1/2"	3/4 GHT	3TLS050GHB	1/2 NPSM	3TLS050SP ¹
	5/8"	3/4 GHT	3TLS062GHB	—	—
	3/4"	3/4 GHT	3TLS075GHB	—	—
	3/4"	3/4 NPSM	3TLS075B	3/4 NPSM	—
	1"	1 NPSM	3TLS100B	1 NPSM	3TLS100SP ¹
	1-1/4"	1-1/4 NPSM	3TLS125B	1-1/4 NPSM	3TLS125DP ²
	1-1/2"	1-1/2 NPSM	3TLS150B	1-1/2 NPSM	3TLS150DP ²
 Female Shank w/ Swivel Nut and Washer	2"	2 NPSM	3TLS200B	2 NPSM	2TLS200DP ²
	3/8"	3/4 GHT	3TLSF037GHB	3/8 NPSM	3TLSF037SP ¹
	1/2"	3/4 GHT	3TLSF050GHB	1/2 NPSM	3TLSF050SP ¹
	5/8"	3/4 GHT	3TLSF062GHB	—	—
	3/4"	3/4 GHT	3TLSF075GHB	—	—
	3/4"	3/4 NPSM	3TLSF075B	3/4 NPSM	3TLSF075SP ¹
	1"	1 NPSM	3TLSF100B	1 NPSM	3TLSF100SP ¹
	1-1/4"	1-1/4 NPSM	3TLSF125B	1-1/4 NPSM	3TLSF125DP ²
1-1/2"	1-1/2 NPSM	3TLSF150B	1-1/2 NPSM	3TLSF150DP ²	
 Male Shank	2"	2 NPSM	3TLSF200B	2 NPSM	3TLSF200DP ²
	3/8"	3/4 GHT	—	3/8 NPSM	—
	1/2"	3/4 GHT	3TLSM050GHB	1/2 NPSM	3TLSM050SP ¹
	5/8"	3/4 GHT	3TLSM062GHB	—	—
	3/4"	3/4 GHT	3TLSM075GHB	—	—
	3/4"	3/4 NPSM	3TLSM075B	3/4 NPSM	3TLSM075SP ¹
	1"	1 NPSM	3TLSM100B	1 NPSM	3TLSM100SP ¹
	1-1/4"	1-1/4 NPSM	3TLSM125B	1-1/4 NPSM	3TLSM125DP ²
	1-1/2"	1-1/2 NPSM	3TLSM150B	1-1/2 NPSM	3TLSM150DP ²
	2"	2 NPSM	3TLSM200B	2 NPSM	3TLSM200DP ²
		¹ Steel-Plated		² Ductile Iron-Plated	

Washer (Buna)



Size	3/8	1/2	3/4	1	1-1/4	1-1/2	2
Part No.	3TRW037	3TRW050	3TRW075	3TRW100	3TRW125	3TRW150	3TRW200







Short Shank Hose Couplings

Brass - Machined, Brass - Cast

Brass - Machined			Part Description
Thread Size and Type (Inches)	Part Number	Hose I.D.	
3/4 GHT	3GGH037B	3/8"	 Complete Set
3/4 GHT	3GGH050B	1/2"	
3/4 GHT	3GGH062B	5/8"	
3/4 GHT	3GGH075B	3/4"	
1 NPSM	3GNP100B	1"	
3/4 GHT	3GGHF037B	3/8"	 Female Shank w/ Swivel Nut & Washer
3/4 GHT	3GGHF050B	1/2"	
3/4 GHT	3GGHF062B	5/8"	
3/4 GHT	3GGHF075B	3/4"	
1 NPSM	3GNPF100B	1"	
3/4 GHT	3GGHM037B	3/8"	 Male Shank
3/4 GHT	3GGHM050B	1/2"	
3/4 GHT	3GGHM062B	5/8"	
3/4 GHT	3GGHM075B	3/4"	
1 NPSM	3GNPM100B	1"	

Brass - Cast			Part Description
3/4 GHT	3TGH037B	3/8"	
3/4 GHT	—	1/2"	
3/4 GHT	3TGH062B	5/8"	
3/4 GHT	3TGH075B	3/4"	
3/4 NPSM	3TNP050B	1/2"	
3/4 NPSM	3TNP062B	5/8"	
3/4 NPSM	3TNP075B	3/4"	
1 NPSM	3TNP100B	1"	 Female Shank w/ Swivel Nut & Washer
3/4 GHT	3TGHF037B	3/8"	
3/4 GHT	3TGHF050B	1/2"	
3/4 GHT	3TGHF062B	5/8"	
3/4 GHT	3TGHF075B	3/4"	
3/4 NPSM	3TNPF050B	1/2"	
3/4 NPSM	3TNPF062B	5/8"	
3/4 NPSM	3TNPF075B	3/4"	 Male Shank
1 NPSM	3TNPF100B	1"	
3/4 GHT	3TGHM037B	3/8"	
3/4 GHT	—	1/2"	
3/4 GHT	3TGHM062B	5/8"	
3/4 GHT	3TGHM075B	3/4"	
3/4 NPSM	3TNPM050B	1/2"	
3/4 NPSM	3TNPM062B	5/8"	
3/4 NPSM	3TNPM075B	3/4"	
1 NPSM	3TNPM100B	1"	

Washer (Buna)

Size	3/4	1
Part No.	3TRW075	3TRW100



Hose Barb Fittings



Standard (Brass)

Part Description	Hose I.D.	Thread NPT	Part Number
 <p>Hose Barb to Male Pipe</p>	1/4"	1/8-27	3GMPB04X02
	1/4"	1/4-18	3GMPB04X04
	5/16"	1/4-18	3GMPB05X04
	3/8"	1/4-18	3GMPB06X04
	3/8"	3/8-18	3GMPB06X06
	3/8"	1/2-14	3GMPB06X08
	3/8"	3/4-14	3GMPB06X12
	1/2"	1/4-18	3GMPB08X04
	1/2"	3/8-18	3GMPB08X06
	1/2"	1/2-14	3GMPB08X08
	1/2"	3/4-14	3GMPB08X12
	5/8"	3/8-18	3GMPB10X06
	5/8"	1/2-14	3GMPB10X08
	5/8"	3/4-14	3GMPB10X12
	3/4"	1/2-14	3GMPB12X08
	3/4"	3/4-14	3GMPB12X12
	1"	3/4-14	3GMPB16X12
	1"	1-11-1/2	3GMPB16X16
	1-1/4"	1-11-1/2	3GMPB20X16
 <p>Hose Barb Mender</p>	1/4"	—	3GMSB04X04
	5/16"	—	3GMSB05X05
	3/8"	—	3GMSB06X06
	1/2"	—	3GMSB08X08
	5/8"	—	3GMSB10X10
	3/4"	—	3GMSB12X12
 <p>Hose Barb to Female Pipe</p>	1/4"	1/4-18	3GFPB04X04
	5/16"	1/4-18	—
	3/8"	1/4-18	3GFPB06X04
	3/8"	3/8-18	3GFPB06X06
	1/2"	1/2-14	3GFPB08X08
 <p>Hose Barb to Female Swivel Ball Seat</p>	1/4"	1/4-18	3GFBS04X04
	3/8"	1/4-18	3GFBS06X04
	3/8"	3/8-18	3GFBS06X06
	1/2"	1/2-14	3GFBS08X08
	3/4"	3/4-14	3GFBS12X12



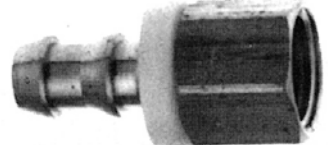

APG universal crowfoot couplings (or “Chicago” fittings as they are commonly called) have easily established a reputation of superiority in the marketplace. They are low carbon steel as opposed to ductile iron – allowing a machined finish beneath the grommet which provides a better seal. And this added benefit even comes with a less expensive price tag!

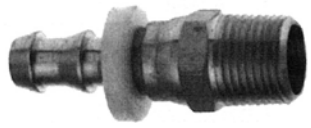
Push-On (Brass)

Part Number	Thread NPT	Hose I.D.	Description
3GHLM04X02	1/8	1/4"	 <p>Hose Barb to Male Pipe</p>
3GHLM04X04	1/4	1/4"	
3GHLM04X06	3/8	1/4"	
3GHLM05X04	1/4	5/16"	
3GHLM06X02	1/8	3/8"	
3GHLM06X04	1/4	3/8"	
3GHLM06X06	3/8	3/8"	
3GHLM06X08	1/2	3/8"	
3GHLM08X04	1/4	1/2"	
3GHLM08X06	3/8	1/2"	
3GHLM08X08	1/2	1/2"	
3GHLM08X12	3/4	1/2"	
3GHLM10X08	1/2	5/8"	
3GHLM10X12	3/4	5/8"	
3GHLM12X08	1/2	3/4"	
3GHLM12X12	3/4	3/4"	
3GHLF04X02	1/8	1/4"	 <p>Hose Barb to Female Pipe</p>
3GHLF04X04	1/4	1/4"	
—	1/4	5/16"	
3GHLF06X04	1/4	3/8"	
3GHLF06X06	3/8	3/8"	
3GHLF08X06	3/8	1/2"	
3GHLF08X08	1/2	1/2"	
3GHJF04X06	9/16-18	1/4"	 <p>Hose Barb to Female Swivel J.I.C. 37° Seat</p>
3GHJF06X06	9/16-18	3/8"	
3GHJF12X12	1-1/16-12	3/4"	
3GHJF16X16	1-5/16-12	1"	
3GHSF04X06	5/8-18	1/4"	 <p>Hose Barb to Female Swivel S.A.E. 45° Seat (Nuts are notched to identify S.A.E. thread)</p>
3GHSF06X06	5/8-18	3/8"	
3GHSF12X12	1-1/16-14	3/4"	
3GHMS04X04	1/4	1/4"	 <p>Hose Barb to Male Pipe Swivel</p>
3GHMS06X04	1/4	3/8"	
3GHMS06X06	3/8	3/8"	
3GHMS08X06	3/8	1/2"	
3GHMS08X08	1/2	1/2"	
3GMHL04X04	—	1/4"	
—	—	5/16"	
3GMHL06X06	—	3/8"	
3GMHL08X08	—	1/2"	
3GMHL10X10	—	5/8"	
3GMHL12x12	—	3/4"	

Male Stems

Male Stems - Plated

Part Description	Hose I.D.	Thread NPT	Part Number
 <p>Male Stem - Collared</p>	1/4"	1/8"	3TSN4X2
	1/4"	1/4"	3TSN4X4
	1/4"	3/8"	3TSN4X6
	3/8"	1/4"	3TSN6X4
	3/8"	3/8"	3TSN6X6
	3/8"	1/2"	3TSN6X8
	1/2"	1/4"	3TSN8X4
	1/2"	3/8"	3TSN8X6
	1/2"	1/2"	3TMS050
	1/2"	3/4"	3TSN8X12
	3/4"	1/2"	3TSN12X8
	3/4"	3/4"	3TMS075
	3/4"	3/4"	*3TMSB075
	1"	3/4"	3TSN16X12
	1"	1"	3TMS100
	 <p>Male Stem - Band Style</p>	1/4"	1/8"
1/4"		1/4"	3TSNB4X4
1/4"		3/8"	3TSNB4X6
3/8"		1/4"	3TSNB6X4
3/8"		3/8"	3TSNB6X6
3/8"		1/2"	3TSNB6X8
1/2"		1/4"	3TSNB8X4
1/2"		3/8"	3TSNB8X6
1/2"		1/2"	3TSNB8X8
1/2"		3/4"	3TSNB8X12
3/4"		1/2"	3TSNB12X8
3/4"		3/4"	3TSNB12X12
1"		3/4"	3TSNB16X12
1"		1"	3TSNB16X16

*Machined Brass

Hose Nozzles

Hose Nozzles - Brass



Description	Part Number
3/4 GHT X 6" Long	3TBNG075
3/4 NPSM X 6" Long	3TBNP075
1 NPSM X 8" Long	3TBNP100
1-1/4 NPSM X 10" Long	3TBNP125
1-1/2 NPSM X 12" Long	3TBNP150
2 NPSM X 12" Long	3TBNP200
2-1/2 NPSM X 12" Long	3TBNP250



Need brass swing check valves? They are on the shelf at APG in seven sizes from 1/2" through 3" inch – ready for same or next day shipment.

Hydraulic Hose Couplings

Clamp Type - Reusable

Size	Part Number
1-1/2"	3TH150
2"	3TH200

Size	Part Number
1-1/2"	3THM150
2"	3THM200

Size	Part Number
1-1/2"	3THC150
2"	3THC200

Complete Set

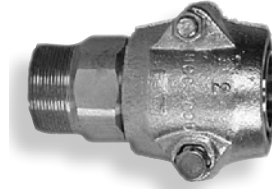

Hydraulic Male Stem



Clamp Ductile-Plated



Size	Hose O.D. Range (Inches)	
	Minimum	Maximum
3 x 2"	2-1/8	2-11/32
	2-5/8	2-13/16

Hydraulic Hose Coupling Sizing Chart



"America's Most Responsive Warehouse"



CALL US



EMAIL







FAX

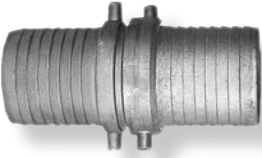

WALK-IN

Pinlug Hose Shank Couplings

Ductile Iron-Plated, Brass, Aluminum

Part Description	Size	Ductile Iron-Plated NPSM	Brass NPSM	Aluminum w/ Brass Nut NPSM	Aluminum w/Brass Nut-NST
 Complete Set	1-1/2"	3TSHC150D	3TSHC150B	3TSHC150AB	3TSHC150ABN
	2"	3TSHC200D	3TSHC200B	3TSHC200AB	—
	2-1/2"	3TSHC250D	—	3TSHC250AB	3TSHC250ABN
	3"	3TSHC300D	3TSHC300B	3TSHC300AB	—
	4"	3TSHC400D	3TSHC400B	3TSHC400AB	—
	6"	3TSHC600D	3TSHC600B	3TSHC600AB	—
 Female Shank	1-1/2"	3TSHF16D	3TSHF16B	3TSHF16AB	3TSHF16ABN
	2"	3TSHF21D	3TSHF21B	3TSHF21AB	—
	2-1/2"	3TSHF26D	3TSHF26B	3TSHF26AB	3TSHF26ABN
	3"	3TSHF31D	3TSHF31B	3TSHF31AB	—
	4"	3TSHF41D	3TSHF41B	3TSHF41AB	—
	6"	3TSHF61D	—	3TSHF61AB	—
Part Description	Size	Ductile Iron-Plated NPSM	Brass NPSM	Aluminum NPSM	Aluminum Nut-NST
 Male Shank	1-1/2"	3TSHM16D	3TSHM16B	3TSHM16A	3TSHM16AN
	2"	3TSHM21D	3TSHM21B	3TSHM21A	—
	2-1/2"	3TSHM26D	—	3TSHM26A	3TSHM26AN
	3"	3TSHM31D	3TSHM31B	3TSHM31A	—
	4"	3TSHM41D	3TSHM41B	3TSHM41A	—
	6"	3TSHM61D	—	3TSHM61A	—
 Swivel Nut	1-1/2"	—	—		
	2"	—	—		
	2-1/2"	—	—		
	3"	—	—		
	4"	—	—		
	6"	—	3TN61B		

Gaskets



Size	Part Number
1-1/2"	3TRW150
2"	3TRW200
2-1/2"	3TRW250
3"	3TRW300
4"	3TRW400
6"	3TRW600

Spanner Wrenches



Size	1-1/2	2	2-1/2	3	4	1-1/2x2-1/2
Part No.	3TW15	3TW20	3TW25	3TW30	3TW40	3TW1525



Have you been passing by opportunities to provide Mil-Spec cam and groove couplings to your customers? Ever-TITE® brass and aluminum cam and groove couplings fulfill the Mil-Spec requirements, and APG can deliver!

Ground Joint Couplings

Fill-Pipe Adapter



Size	Part Number
1/2"	3TGJ050
3/4"	3TGJ075
1"	3TGJ100
1-1/4"	3TGJ125
1-1/2"	3TGJ150
2"	3TGJ200
2-1/2"	3TGJ250
3"	3TGJ300
4"	3TGJ400

Size	Part Number
1/2"	3TGS050
3/4"	3TGS075
1"	3TGS100
1-1/4"	3TGS125
1-1/2"	3TGS150
2"	3TGS200
2-1/2"	3TGS250
3"	3TGS300
4"	3TGS400

Stem



Wing Nut



Size	Part Number
1/2"	3TWN050
3/4"	3TWN075/100
1"	3TWN075/100
1-1/4"	3TWN125/150
1-1/2"	3TWN125/150
2"	3TWN200
2-1/2"	3TWN250
3"	3TWN300
4"	3TWN400

Size	Part Number
1/2"	3TFS050
3/4"	3TFS075
1"	3TFS100
1-1/4"	3TFS125
1-1/2"	3TFS150
2"	3TFS200
2-1/2"	3TFS250
3"	3TFS300
4"	3TFS400

Female Spud



Double Spud



Size	Part Number
3/4"	3TGJDS75/100
1"	3TGJDS75/100

Size	Part Number
3/4"	3TGJMS075
1"	3TGJMS100

Male Spud

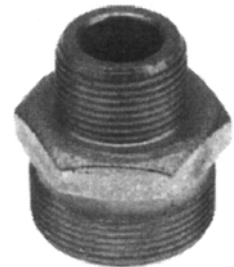

CALL US



EMAIL



FAX



WALK-IN

"AMERICA'S MOST RESPONSIVE WAREHOUSE"

Male Stems

Size	1/2	3/4	1	1-1/4	1-1/2	2	2-1/2	3	4
Part No.	3TMS050	3TMS075	3TMS100	3TMS125	3TMS150	3TMS200	3TMS250	3TMS300	3TMS400

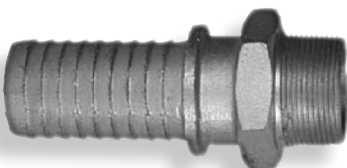

Valves

Ball Valves

Brass Standard Port 400 PSI WOG

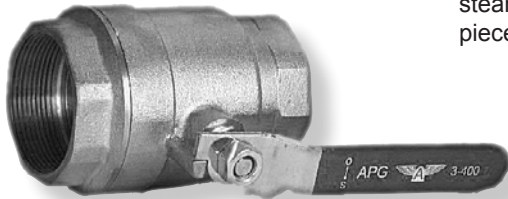

Forged Brass body and connector. Chromium Plated brass ball. Viton® Stem Seal, Teflon® Seats. Bottom Entry, Blow-out proof stem, 125 PSI Saturated steam. Threaded NPT Female X Female. Two piece design

Size	Part Number
1/2"	3V04B050
3/4"	3V04B075
1"	3V04B100
1-1/4"	3V04B125
1-1/2"	3V04B150
2"	3V04B200
2-1/2"	3V04B250
3"	3V04B300
4"	3V04B400

Brass Full Port 400 PSI WOG



Forged Brass body and connector. Chromium Plated Brass Ball. Viton® Stem Seal, Teflon® Seats. Bottom Entry, Blow-out Proof Stem, 125 PSI saturated steam. Threaded NPT Female X Female. Two piece design

Size	Part Number
1/2"	3V04BF050
3/4"	3V04BF075
1"	3V04BF100
1-1/4"	3V04BF125
1-1/2"	3V04BF150
2"	3V04BF200

Brass Standard Port 600 PSI WOG

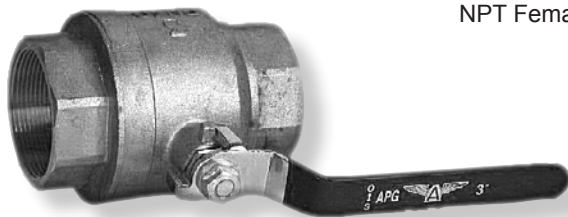

Forged Brass body and connector. Chromium Plated Brass ball. Brass Stem, Cap, Gland Cap, Nut, Seat, Thrust Washer, Cap Washer and Packing are Brass. Handle and Washer are Steel. Handle Cover is Vinyl. Threaded NPT Female X Female. Two piece design

Size	Part Number
1/4"	3V06BS025
3/8"	3V06BS037
1/2"	3V06BS050
3/4"	3V06BS075
1"	3V06BS100
1-1/4"	3V06BS125
1-1/2"	3V06BS150
2"	3V06BS200
3"	3V06BS300

Brass Full Port 600 PSI WOG

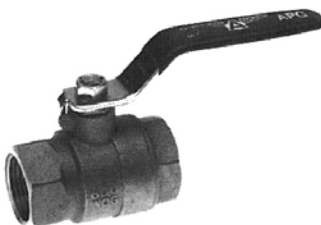

Forged Brass body and connector. Chromium Plated Brass Ball. Brass Stem. Seats, Stem Seal, and Stem Washer are Teflon®. Threaded NPT Female X Female. Two piece design.

Size	Part Number
1/4"	3V06B025
3/8"	3V06B037
1/2"	3V06B050
3/4"	3V06B075
1"	3V06B100
1-1/4"	3V06B125
1-1/2"	3V06B150
2"	3V06B200
2-1/2"	3V06B250
3"	3V06B300
4"	3V06B400



Don't let week-end, holiday, or after-hours sales opportunities pass you by. APG has an emergency call-out service that has you covered – just call the same number that you always call – any time – day or night.

Size	Part Number
1/2"	3V08S050
3/4"	3V08S075
1"	3V08S100
1-1/4"	3V08S125
1-1/2"	3V08S150
2"	3V08S200
2-1/2"	3V08S250
3"	3V08S300
4"	3V08S400

316 Stainless Steel body and ball.
Teflon® Stem, seal and seat.
304 Stainless Steel handle and locking handle clip. Threaded NPT Female x Female. Temperature Range:-60 to 450° F.
One piece design.

**Stainless Steel
Standard Port
1000 PSI WOG**



Size	Part Number
1/4"	3V01SF025
3/8"	3V01SF037
1/2"	3V01SF050
3/4"	3V01SF075
1"	3V01SF100
1-1/4"	3V01SF125
1-1/2"	3V01SF150
2"	3V01SF200
2-1/2"	3V01SF250
3"	3V01SF300

316 Stainless Steel body and ball.
Teflon® Stem, seal and seat.
304 Stainless Steel handle and locking handle clip. Threaded NPT Female x Female. Temperature Range:-60 to 450° F.
Two piece design

**Stainless Steel
Full Port 1000
PSI WOG**



Gate Valves

Forged Brass body and connector. Chromium Plated Brass Ball. Viton® Stem Seal, Teflon® Seats. Bottom Entry, Blow-out Proof Stem, 125 PSI Saturated Steam. Threaded NPT Female X Female. Two piece design

**Brass
200 PSI WOG**



Size	Part Number
1/4"	3V02GB025
3/8"	3V02GB037
1/2"	3V02GB050
3/4"	3V02GB075
1"	3V02GB100
1-1/4"	3V02GB125
1-1/2"	3V02GB150
2"	3V02GB200
2-1/2"	3V02GB250
3"	3V02GB300
4"	3V02GB400

Swing Check Valves

**Brass
200 PSI WOG**

Size	Part Number
1/2"	3V02CV050
3/4"	3V02CV075
1"	3V02CV100
1-1/4"	3V02CV125
1-1/2"	3V02CV150
2"	3V02CV200
3"	3V02CV300



We have Multiple Locations!



CALL US



EMAIL



FAX



WALK-IN

"AMERICA'S MOST RESPONSIVE WAREHOUSE"



Quick Disconnect Couplers and Plugs

Industrial Interchange Series

Standard Couplers have brass adapters and barrels, heat treated steel sleeves and valves, Stainless Steel balls and springs. Brass Couplers are all brass with Stainless Steel balls and springs. All couplers have Buna-N washers. Couplers have an automatic shutoff valve which seals off instantly upon uncoupling. Maximum working pressure is 300 PSIG. Use on compressed air lines only. Couplers meet MIL Spec 4109.



ALSO AVAILABLE: All Stainless Steel (Type 303). Brass Chrome (Nickel Chrome plated brass).

1/4" Couplers

Description	Size	Part Number
 Male NPT	1/8"	3Q4C2M
	1/4"	3Q4C4M
	1/4"	3Q4C4M-B ¹
	3/8"	3Q4C6M
 Female NPT	1/8"	3Q4C2F
	1/4"	3Q4C4F
	1/4"	3Q4C4F-B ¹
	3/8"	3Q4C6F
 Hose Barb	1/4"	3Q4C4S
	5/16"	3Q4C5S
	3/8"	3Q4C6S



¹ Brass

1/4" Adapters



Description	Size	Part Number
 Male NPT	1/8"	3Q4P2M
	1/4"	3Q4P4M
	1/4"	3Q4P4M-B ¹
	3/8"	3Q4P6M
 Female NPT	1/8"	3Q4P2F
	1/4"	3Q4P4F
	1/4"	3Q4P4F-B ¹
	3/8"	3Q4P6F
 Hose Barb	1/4"	3Q4P4S
	5/16"	3Q4P5S
	3/8"	3Q4P6S

¹ Brass



3/8" Couplers

Description	Size	Part Number
 Male NPT	1/4"	3Q6C4M
	3/8"	3Q6C6M
	1/2"	3Q6C8M
 Female NPT	1/4"	3Q6C4F
	3/8"	3Q6C6F
	1/2"	3Q6C8F
 Hose Barb	1/4"	3Q6C4S
	3/8"	3Q6C6S
	1/2"	3Q6C8S



3/8" Adapters

Description	Size	Part Number
 Male NPT	1/4"	3Q6P4M
	3/8"	3Q6P6M
	1/2"	3Q6P8M
 Female NPT	1/4"	3Q6P4F
	3/8"	3Q6P6F
	1/2"	3Q6P8F
 Hose Barb	1/4"	—
	3/8"	3Q6P6S
	1/2"	3Q6P8S

1/2" Couplers

Description	Size	Part Number
 Male NPT	3/8"	3Q8C6M
	1/2"	3Q8C8M
	3/4"	3Q8C12M
 Female NPT	3/8"	3Q8C6F
	1/2"	3Q8C8F
	3/4"	3Q8C12F
 Hose Barb	3/8"	3Q8C6S
	1/2"	3Q8C8S
	3/4"	3Q8C12S

1/2" Adapters

Description	Size	Part Number
 Male NPT	1/4"	3Q8P6M
	3/8"	3Q8P8M
	1/2"	3Q8P12M
 Female NPT	1/4"	3Q8P6F
	3/8"	3Q8P8F
	1/2"	3Q8P12F
 Hose Barb	1/4"	3Q8P6S
	3/8"	3Q8P8S
	1/2"	3Q8P12S



Don't let week-end, holiday, or after-hours sales opportunities pass you by. APG has an emergency call-out service that has you covered – just call the same number that you always call – any time – day or night.

Quick Disconnect Couplings - Cross Reference Charts

	APG	AMFLO	ARO	COILHOSE	FOSTER	HANSEN	HOFFMAN	MILTON	PARKER	SHRADER	TRUFLATE	
Couplers	3Q8C8M	C9	—	122	5305	530	MC4	1816	16	3511	13-704	
	3Q8C6M	C9-03	—	121	5105	510	MC3	1814	16E	—	—	
	3Q8C12M	C9-06	—	—	5505	—	MC5	—	16G	—	—	
	3Q8C8F	C10	—	120	5205	520	FC4	1815	17	3512	13-712	
	3Q8C6F	C10-23	—	123	5005	500	FC3	1813	17E	3516	13-710	
	3Q8C12F	C10-26	—	—	5405	—	FC5	—	17G	—	—	
	3Q8C6S	C10-44	—	—	5705	—	SC3	—	16-5B	—	—	
	3Q8C8S	C10-45	—	—	5805	—	SC4	—	16-6B	—	—	
	3Q8C12S	C10-46	—	—	5905	—	SC5	—	16-7B	—	13-766	
	3Q4C4F	C20	23102-200	150	3003	3000	FA2	715	23	5142-12	13-234	
	3Q4C4F-B	C20B	—	—	3003B	22AS25M	FA2-B	—	B23	—	—	
	3Q4C2F	C20-21	23102-1	158	2803	2800	FA1	707	—	—	—	
	3Q4C6F	C20-23	23102-3	151	3203	3200	FA3	718	—	5263-12	—	
	3Q4C4S	C20-42	23102-22	—	3603	22AS25H	SA2	717	B20-3B	—	13-264	
	3Q4C5S	C20-43	23101-001	—	3653	22AS31H	SA25	—	20-4B	—	—	
	3Q4C6S	C20-44	23102-024	—	3703	22AS37H	SA3	717-6	20-5B	—	—	
	3Q4C4M	C21	23102-212	152	3103	3100	MA2	716	22	5141-12	13-224	
	3Q4C4M-B	C21B	—	—	3103B	22AS25M	MA2-B	—	B22	—	—	
	3Q4C2M	C21-01	23102-11	159	2903	2900	MA1	708	—	—	—	
	3Q4C6M	C21-03	23102-213	155	3303	3300	MA3	719	—	5140-12	—	
	3Q6C6M	C25	23103-313	581	4304	4300	MB3	1836	24	—	13-526	
	3Q6C4M	C25-02	23103-012	—	4104	—	MB2	—	24C	—	—	
	3Q6C8M	C25-04	23103-14	—	4504	—	MB4	—	24F	—	—	
	3Q6C6F	C26	23103-300	580	4204	4200	FB3	1835	25	3541	13-536	
	3Q6C4F	C26-22	23103-002	—	4004	—	FB2	1833	25C	—	—	
	3Q6C8F	C26-24	23103-004	—	4004	—	FB4	1836-6	25F	—	—	
	3Q6C4S	C26-42	23103-22	—	4604	—	SB2	—	—	—	—	
	3Q6C6S	C26-44	23103-324	—	4804	—	SB3	—	24-5B	—	13-566	
	3Q6C8S	C26-45	23103-25	—	4904	—	SB4	—	24-6B	—	—	
	Plugs	3Q8P8M	wCP-17	23904-410	1201	54-5	54	MPC4	1857	H2F	—	12-752
		3Q8P6M	CP-17-03	23904-310	—	52-5	52	MPC3	1859	H0F	—	—
		3Q8P12M	CP17-06	23904-510	—	56-5	56	MPC5	—	H2F-G	—	—
		3Q8P6S	CP17-44	23904-420	—	59-5	59	SPC3	—	H4F	—	—
3Q8P8S		CP17-45	23904-520	—	60-5	60	SPC4	—	H5F	—	12-760	
3Q8P12S		CP17-46	23904-620	—	71-3	—	SPC5	—	H5F-G	—	—	
3Q8P8F		CP18	23904-400	1202	55-5	55	FPC4	1858	H3F	—	12-762	
3Q8P6F		CP18-23	23904-003	—	53-5	53	FPC3	1860	H1F	—	—	
3Q8P12F		CP18-26	23904-005	—	57-5	57	FPC5	—	H3F-G	—	—	
3Q4P4F		CP20	23902-200	1502	11-3	11	FPA2	728	H3C	5137-11	12-234	
3Q4P4F-B		CP20B	—	—	11-3B	B-11	FPA2-B	—	BH3C	—	—	
3Q4P2F		CP20-21	23902-100	—	13-3	—	FPA1	—	H1C	—	—	
3Q4P6F		CP20-23	23902-3	1505	15-3	15	FPA3	732	H3C-E	5263-11	12-236	
3Q4P4M		CP21	23902-310	1501	10-3	10	MPA2	727	H2C	5138-11	12-224	
3Q4P4M-B		CP21B	—	—	10-3B	B-10	MPA2-B	—	BH2C	—	—	
3Q4P2M		CP21-01	23902-110	—	12-3	12	MPA1	726	H0C	—	—	
3Q4P6M		CP21-03	23902-310	1503	14-3	14	MPA3	733	H2C-3	—	12-226	
3Q4P4S		CP21-42	23902-220	—	16-3	16	SPA2	736	H8C	5223-11	12-265	
3Q4P5S		CP21-43	23902-320	—	165-3	18	SPA25	—	H8C-D	—	—	
3Q4P6S		CP21-44	23902-420	—	17-3	17	SPA3	736-6	HK9C	—	12-226	
3Q6P6M		CP25	23903-310	5801	42-4	42	MPB3	1837	H2E	3542	12-526	
3Q6P4M		CP25-02	23902-210	—	40-4	40	MPB2	1839	H0E	—	—	
3Q6P8M		CP25-04	23903-410	—	44-4	44	MPB4	—	H2E-F	—	—	
—		C25-42	23903-320	—	46-4	404	SPB2	—	—	—	—	
3Q6P6S		C25-44	23903-420	—	48-4	406	SPB3	1837-6	H5E	—	12-566	
3Q6P8S		C25-45	23903-520	—	49-4	408	SPB4	—	H5E	—	—	
3Q6P6F		CP26	23903-300	5802	43-4	43	FPB3	1838	H3E	3543	12-536	
3Q6P4F		CP26-22	23903-300	—	41-4	41	FPB2	1840	H1E	—	—	
3Q6P8F		CP26-24	23903-004	—	45-4	45	FPB4	—	H3E-F	—	—	

Conbraco Water Gauges

Rough Brass

20-100 Series



Self cleaning. Tested for pressure to 125 pounds. 1/4" needle drain valve in lower arm - standard.

Pipe Size	Glass Size	Wheel Type	Part Number
1/2"	5/8"	Aluminum	3C20-104
1/2"	5/8"	Composition	3C20-105

20-100 Series



Self cleaning. Tested for pressure to 200 pounds with standard glass. 250 pounds with hi-pressure glass. 1/4" needle drain valve in lower arm - standard.

Pipe Size	Glass Size	Wheel Type	Part Number
1/2"	5/8"	Aluminum	3C20-204
1/2"	5/8"	Composition	3C20-205
3/4"	3/4"	Aluminum	3C20-207

The 20-150 Series, 20-250 Series, and 20-350 Series listed below are equipped with ball checks to prevent scalding the operator in event of glass breakage. The sudden rush of steam and water will carry the balls to their seats thereby shutting off the escape of steam and water. 1/4" Needle Drain Valve in Lower Arm-Standard- 1/4" Petcock in Lower Arm Available Upon Request.

20-150 Series Standard Pattern

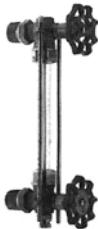

Tested for pressure to 125 pounds; with ball check.

Pipe Size	Glass Size	Wheel Type	Part Number
1/2"	5/8"	Aluminum	3C20-150
1/2"	5/8"	Composition	3C20-151

20-250 Series Heavy Pattern



Tested for pressure to 200 pounds with standard glass. 250 pounds with hi-pressure glass; with ball check.

Pipe Size	Glass Size	Wheel Type	Part Number
1/2"	5/8"	Aluminum	3C20-250

20-350 Series



Tested for pressure to 200 pounds with standard glass. 250 pounds with hi-pressure glass; with ball check.

Pipe Size	Glass Size	Wheel Type	Part Number
1/2"	5/8"	Aluminum	3C20-350
3/4"	3/4"	Aluminum	3C20-350



APG brand worm gear clamps are all 316 Stainless Steel and cost less than competitive brands with carbon steel screws and housings. So what's not to like?

Self cleaning. Tested for 250 pounds pressure with hi-pressure glass. Ball checks in the upper and lower arms prevent the escape of steam and water should the gauge glass be accidentally broken. The sudden rush of steam and water carry the balls to their seats, immediately shutting off the escape of steam and water.

Pipe Size	Glass Size	Wheel Type	Part Number
1/2"	5/8"	Aluminum	3C25-501
1/2"	5/8"	Composition	3C25-502
3/4"	3/4"	Aluminum	3C25-504

Polished Brass

20-100 Series



Replacement Parts for Water Gauges

For 125# Gauges

Aluminum Wheels



Part Number
3CH-2435

Brass Nut

Size	Part Number
5/8"	3CC-1408
3/4"	3CC-1407

Brass Washer

Size	Part Number
5/8"	3CE-1819
3/4"	3CE-1818

Rubber Washer

Size	Part Number
5/8"	3CD-1600
3/4"	3CD-1606

Size	Wheel Type	Part Number
5/8"	Aluminum	3C26-304-28

Note:

Conbraco Water Gauges do not include glass tubing or brass guard rods. APG can supply both items. Glass tubing can be cut to your specifications utilizing Standard Gauge Glass, High Pressure, Red Line, Heavy Wall and Red Line Heavy Wall Gauge Glass. (Rigid plastic tubing also available.)

Formula for determining Glass and Rod:

—Glass is 1-1/4" shorter than centerline to centerline dimension. Rods are 2" longer than glass.

Exception:

—For 20-350, glass is 2" shorter than centerline dimension. Rods are 1-1/4" longer than glass.

Compression Gauge Cock

26-300 Series



Pressure Gauges

Black Steel Case Brass Lower Connection



Pressure Range psi/bar (100 x kPa)	1-1/2" Face 1/8" Connection	2" Face 1/4" Connection	2-1/2" Face 1/4" Connection	4" Face 1/4" Connection
*30(vac)/-1	—	—	3D25200ND02L30V	—
*30-0-30/-1 to 2	—	—	3D25200ND02L30V30	—
0-30/0-2	3D15200ND01L30	3D20200ND02L30	3D25200ND02L30	3D40400ND02L30
0-60/0-4	3D15200ND01L60	3D20200ND02L60	3D25200ND02L60	3D40400ND02L60
0-100/0-7	3D15200ND01L100	3D20200ND02L100	3D25200ND02L100	3D40400ND02L100
0-160/0-11	3D15200ND01L160	3D20200ND02L160	3D25200ND02L160	3D40400ND02L160
0-200/0-14	—	—	3D25200ND02L200	3D40400ND02L200
0-300/0-20	—	—	3D25200ND02L300	3D40400ND02L300
0-400/0-25	—	—	3D25200ND02L400	3D40400ND02L400
0-600/0-40	—	—	3D25200ND02L600	3D40400ND02L600
0-1000/0-70	—	—	—	3D40400ND02L1000
0-1500/0-100	—	—	—	—
0-2000/0-140	—	—	—	3D40400ND02L2000
0-3000/0-200	—	—	—	3D40400ND02L3000

*in. Hg

Black Steel Case Brass Back Connection



Pressure Range psi/bar (100 x kPa)	1-1/2" Face 1/8" Connection	2" Face 1/4" Connection	2-1/2" Face 1/4" Connection
*30(vac)/-1	—	—	3D25200ND02B30V
*30-0-30/-1 to 2	—	—	3D25200ND02B30V30
0-30/0-2	3D15200ND01B30	3D20200ND02B30	3D25200ND02B30
0-60/0-4	3D15200ND01B60	3D20200ND02B60	3D25200ND02B60
0-100/0-7	3D15200ND01B100	3D20200ND02B100	3D25200ND02B100
0-160/0-11	3D15200ND01B160	3D20200ND02B160	3D25200ND02B160
0-200/0-14	—	—	3D25200ND02B200
0-300/0-20	—	—	3D25200ND02B300
0-400/0-25	—	—	3D25200ND02B400
0-600/0-40	—	—	—

*in. Hg

Please call for availability of other styles and pressure ranges.



Don't let the pressure get to you! With over 150 different pressure gauges in our inventory, APG can help you and your customers manage the pressure. Dry, liquid filled, black steel or Stainless Steel – they are all on the shelf.

QUICK TURNAROUND!!



CALL US



EMAIL



FAX



WALK-IN

"AMERICA'S MOST RESPONSIVE WAREHOUSE"

**Stainless Steel Case
Brass Lower Connection
Liquid Filled**

Pressure Range psi/bar (100 x kPa)	1-1/2" Face 1/8" Connection	2-1/2" Face 1/4" Connection	4" Face 1/4" Connection
*30(vac)/-1	—	3D25400FG02L30V	—
*30-0-30/-1 to 2	—	3D25400FG02L30V30	—
0-30/0-2	3D15400FG01L30	3D25400FG02L30	3D40400FG02L30
0-60/0-4	3D15400FG01L60	3D25400FG02L60	3D40400FG02L60
0-100/0-7	3D15400FG01L100	3D25400FG02L100	3D40400FG02L100
0-160/0-11	3D15400FG01L160	3D25400FG02L160	3D40400FG02L160
0-200/0-14	—	3D25400FG02L200	3D40400FG02L200
0-300/0-20	—	3D25400FG02L300	3D40400FG02L300
0-400/0-25	—	3D25400FG02L400	—
0-600/0-40	—	3D25400FG02L600	3D40400FG02L600
0-1000/0-70	—	3D25400FG02L1000	3D40400FG02L1000
0-1500/0-100	—	3D25400FG02L1500	3D40400FG02L1500
0-2000/0-140	—	3D25400FG02L2000	3D40400FG02L2000
0-3000/0-200	—	3D25400FG02L3000	3D40400FG02L3000
0-5000/0-315	—	3D25400FG02L5000	3D40400FG02L5000
0-10000/0-700	—	—	—
0-15000/0-10000	—	—	—

*in. Hg



**Stainless Steel Case
Brass Back Connection
Liquid Filled**

Pressure Range psi/bar (100 x kPa)	1-1/2" Face 1/8" Connection	2-1/2" Face 1/4" Connection
*30(vac)/-1	—	3D25400FG02B30V
*30-0-30/-1 to 2	—	3D25400FG02B30V30
0-30/0-2	3D15400FG01B30	3D25400FG02B30
0-60/0-4	3D15400FG01B60	3D25400FG02B60
0-100/0-7	3D15400FG01B100	3D25400FG02B100
0-160/0-11	3D15400FG01B160	3D25400FG02B160
0-200/0-14	3D15400FG01B200	3D25400FG02B200
0-300/0-20	—	3D25400FG02B300
0-400/0-25	—	3D25400FG02B400
0-600/0-40	—	3D25400FG02B600
0-1000/0-70	—	3D25400FG02B1000
0-1500/0-100	—	3D25400FG02B1500
0-2000/0-140	—	3D25400FG02B2000
0-3000/0-200	—	3D25400FG02B3000
0-5000/0-315	—	3D25400FG02B5000
0-10000/0-700	—	—
0-15000/0-10000	—	—

*in. Hg



Please call for availability of other styles and pressure ranges.

All Stainless Steel Lower Connection Liquid Filled



Pressure Range psi/bar (100 x kPa)	2-1/2" Face 1/4" Connection	4" Face 1/4" Connection
*30(vac)/-1	3D25500FG02L30V	—
*30-0-30/-1 to 2	—	—
0-30/0-2	3D25500FG02L30	3D40500FG04L30
0-60/0-4	3D25500FG02L60	3D40500FG04L60
0-100/0-7	3D25500FG02L100	3D40500FG04L100
0-160/0-11	3D25500FG02L160	3D40500FG04L160
0-200/0-14	3D25500FG02L200	3D40500FG04L200
0-300/0-20	3D25500FG02L300	3D40500FG04L300
0-400/0-25	3D25500FG02L400	3D40500FG04L400
0-600/0-40	3D25500FG02L600	3D40500FG04L600
0-1000/0-70	3D25500FG02L1000	3D40500FG04L1000
0-1500/0-100	3D25500FG02L1500	—
0-2000/0-140	3D25500FG02L2000	3D40500FG04L2000
0-3000/0-200	3D25500FG02L3000	3D40500FG04L3000
0-5000/0-315	3D25500FG02L5000	3D40500FG04L5000
0-10000/0-700	—	—
0-15000/0-10000	—	—



1/4" to 1/2" Brass Connection Adapter

Part Number

3D200010



2-1/2" C-Clamp

Part Number

3D91PBS2.5



The APG On-Line Ordering System can be used for much more than just placing orders. Order tracking, quotes, price checks, account information, and more

Clamps (Ductile Iron-Plated)

Hose O.D. Ranger (Inches)		Part Number
Minimum	Maximum	
21/32	7/8	3T0022
7/8	1-9/64	3T0029
1-5/16	1-11/32	3T0034
1-5/16	1-19/32	3T0040
1-5/8	1-15/16	3T0049
1-7/8	2-3/8	3T0060
2-3/8	3-1/16	3T0076
3-1/4	3-11/16	3T0094
3-1/2	4	3T0400
4-1/16	4-7/16	3T0463
4-3/16	5	3T0525
5	5-1/2	3T0550
5-1/2	6-1/16	3T0600
6-1/8	6-7/8	3T0675
6-15/16	7-5/8	3T0769
7-11/16	8-3/16	3T0818
8-1/4	8-7/8	3T0875
8-15/16	9-7/8	3T0988
9-15/16	11-3/8	3T1125
11-3/16	13	3T1275
12-3/16	14	3T1360
13-3/16	15	3T1450
15-1/16	17-1/2	3T1700

Hose I.D.	Hose O.D. Ranger (Inches)		Part Number
	Minimum	Maximum	
3/8"	11/16	3/4	3TUC037
1/2"	15/16	1-1/16	3THPC050
3/4"	1-1/8	1-5/16	3TUC075

Hose I.D.	Hose O.D. Ranger (Inches)		Part Number
	Minimum	Maximum	
1/2"	15/16	1-1/16	3THPC050 (2-Bolt)
1/2"	1-1/16	1-3/16	3THPC050OS (2-Bolt)
3/4"	1-3/16	1-5/16	3THPC075U (2-Bolt)
3/4"	1-5/16	1-1/2	3THPC075 (2-Bolt)
3/4"	1-1/2	1-11/16	3THPC075OS (2-Bolt)
1"	1-17/32	1-23/32	3THPC100U (4-Bolt)
1-1/4"	2-1/16	2-1/4	3THPC125 (4-Bolt)
1-1/2"	2-3/32	2-9/32	3THPC150U (4-Bolt)
1-1/2"	2-1/4	2-7/16	3THPC150 (4-Bolt)
1-1/2"	2-15/32	2-23/32	3THPC150OS (4-Bolt)
2"	2-1/2	2-25/32	3THPC200U (4-Bolt)
2"	2-3/4	3-1/16	3THPC200 (4-Bolt)
2"	3-3/32	3-7/16	3THPC200OS (4-Bolt)
2-1/2"	3-1/2	3-15/16	3THPC250 (4-Bolt)
3"	3-13/16	4-3/16	3THPC300U (4-Bolt)
3"	4-1/16	4-7/16	3THPC300 (4-Bolt)
3"	4-1/4	4-13/16	3THPC400U (6-Bolt)
4"	4-7/8	5-5/16	3THPC400 (6-Bolt)
4"	5-1/8	6-3/16	3THPC400OS (6-Bolt)

Hose I.D.	Part Number
3/4"	3TAR88DB12
1"	3TAR88DB16
1-1/4"	3TAR88DB20
1-1/2"	3TAR88DB24
2"	3TAR88DB32

Double Bolt Clamp



Universal Clamp

(For Universal Couplings)



High Pressure Clamp



Heavy Duty Clamp (2 Bolt)





Spiral Clamps

Spiral Clamp - Right



Size	Part Number
1-1/2"	3TSCR150
2"	3TSCR200
2-1/2"	3TSCR250
3"	3TSCR300
4"	3TSCR400
5"	3TSCR500
6"	3TSCR600
8"	3TSCR800
10"	—
12"	3TSCR1200

Spiral Clamp - Left



Size	Part Number
1-1/2"	3TSCL150
2"	3TSCL200
2-1/2"	3TSCL250
3"	3TSCL300
4"	3TSCL400
5"	3TSCL500
6"	3TSCL600
8"	3TSCL800
10"	3TSCL1000
12"	3TSCL1200



We have LARGE inventories!!



CALL US



EMAIL



FAX



WALK-IN

"AMERICA'S MOST RESPONSIVE WAREHOUSE"



When many people think of APG EVER-TITE® couplings, they think “Cam and Groove Couplings.” And this is great, because they are the best cam and groove values on the market. But don’t forget all the other products in our Industrial Hose Coupling Catalog.



BAND-IT® offers a complete clamping system to provide clamps that are universally recognized as efficient, easy to apply, and superior in quality. They are designed to secure hoses, pipes, poles, and cables as well as perform scores of other clamping functions.

The items described in this catalog represent primarily those items stocked by APG. Other products in the BAND-IT® Catalog are available by special order. Ask your APG sales representative for complete information.



Type 201 Stainless Steel

For high strength and corrosion resistance. 100 ft per roll (30.5M)

Part Number	Width		Thickness		Weight	
	Inches	mm	Inches	mm	Lbs	Kg
3BC202	1/4	6.35	.020	.51	1.7	.9
3BC203	3/8	9.53	.025	.63	3.2	1.6
3BC204	1/2	12.70	.030	.76	5.1	2.4
3BC205	5/8	15.88	.030	.76	6.4	3.0
3BC206	3/4	19.05	.030	.76	7.7	3.6

Type 316 Stainless Steel

For use when corrosion is the major problem - moist atmospheres or environments with chemicals, salts, acids or high temperatures. 100 ft per roll (30.5M).

Part Number	Width		Thickness		Weight	
	Inches	mm	Inches	mm	Lbs	Kg
3BC402	1/4	6.35	.020	.51	1.7	.9
3BC403	3/8	9.53	.025	.63	3.2	1.6
3BC404	1/2	12.70	.030	.76	5.1	2.4
3BC405	5/8	15.88	.030	.76	6.4	3.0
3BC406	3/4	19.05	.030	.76	7.7	3.6

Bold Text not normally APG stock item. Special Order.

BAND-IT® Band

Fully rounded smooth edges for safety and easy installation. For clamps of even greater strength, use a double wrap, threading the Ear-Lokt Buckle each time around.

Galvanized Carbon Steel

For applications which do not demand high strength or corrosion protection. 100 ft per roll (30.5M).

Part Number	Width		Thickness		Weight	
	Inches	mm	Inches	mm	Lbs	Kg
3BC303	3/8	9.53	.025	.63	3.3	1.6
3BC304	1/2	12.70	.030	.76	5.1	2.4
3BC305	5/8	15.88	.030	.76	6.4	3.0
3BC306	3/4	19.05	.030	.76	7.7	3.6

Giant Band

Type 201 Stainless Steel (Also available in Galvanized carbon steel.) Used for heavy duty clamping applications. 1-1/4” band in 201 Stainless Steel has a braking strength of 5,500 pounds. Double wrapped clamps recommended for maximum strength. 100 ft roll (30.5M).

Part Number	Width		Thickness		Weight	
	Inches	mm	Inches	mm	Lbs	Kg
3BG430	3/4	19.05	.044	1.12	11.6	5.4
3BG431	1	25.40	.044	1.12	13.7	6.4
3BG432	1-1/4	31.75	.044	1.12	17.2	8.0

Bold Text not normally APG stock item. Special Order.

BAND-IT® Buckles

Ear-Lokt Buckles accommodate single and double warp clamps. Unique teeth and ears provide maximum clamping strength.

Type 201 Stainless Steel

Packing Quantity - 100

Part Number	Width		Weight	
	Inches	mm	Lbs	Kg
3BC252	1/4	6.35	.3	.1
3BC253	3/8	9.53	.8	.4
3BC254	1/2	12.70	2.1	1.0
3BC255	5/8	15.88	2.4	1.1
3BC256	3/4	19.05	3.7	1.7

Type 316 Stainless Steel

Packing Quantity - 100

Part Number	Width		Weight	
	Inches	mm	Lbs	Kg
3BC452	1/4	6.35	.3	.1
3BC453	3/8	9.53	.8	.4
3BC454	1/2	12.70	2.1	1.0
3BC455	5/8	15.88	2.4	1.1

Bold Text not normally APG stock item. Special Order.

Valustrap™ and Valuclips™

For light duty jobs such as cable-bundling, mounting small signs or street decorations, or for applying energy saving insulation around pipes or tanks.

Austenitic, non-magnetic Stainless Steel. 100 ft rolls (30.5M). Also available by special order in 200 and 300 ft rolls.

Thickness - .015" (.38mm)

Valustrap™

Part Number	Width		Weight	
	Inches	mm	Lbs	Kg
3BC133	3/8	9.53	2.2	1.0
3BC134	1/2	12.70	2.9	1.3
3BC135	5/8	15.88	3.6	1.7
3BC136	3/4	19.06	4.4	2.0



Valuclips™

Reinforced with angle ribs for extra strength. Type 304 Stainless Steel.

Part Number	Width		Weight	
	Inches	mm	Lbs	Kg
3BC153	3/8	9.53	.6	.3
3BC154	1/2	12.70	1.1	.5
3BC155	5/8	15.88	1.2	.5
3BC156	3/4	19.05	2.1	.9

Bold Text not normally APG stock item. Special Order.

Note: BAND-IT® also offers Valustrap Plus and Valuband for heavy duty applications. Special order.



APG universal crowfoot couplings (or “Chicago” fittings as they are commonly called) have easily established a reputation of superiority in the marketplace. They are low carbon steel as opposed to ductile iron – allowing a machined finish beneath the grommet which provides a better seal. And this added benefit even comes with a less expensive price tag!

Scru-Lok™ Buckles

In this application, BAND-IT® Band is secured in the buckle with a set screw. Ahex wrench for this purpose comes with the buckles. Use Scru-Lok® Buckles when close quarters will not permit the roll-over action of the BAND-IT® Tool, or when a temporary or adjustable clamp is desired. Stainless Steel. Reusable.

Scru-Lok Buckles

Part Number	Width		Pkg Qty	Weight	
	Inches	mm		Lbs	Kg
3BC720	1/4	6.35	50	.3	.1
3BC722	3/8	9.53	50	.5	.2
3BC724	1/2	12.70	25	.5	.2
3BC725	5/8	15.88	25	.8	.4
3BC726	3/4	19.05	25	.9	.4



Same or Next Day Shipping!



CALL US



EMAIL



FAX



WALK-IN

“AMERICA’S MOST RESPONSIVE WAREHOUSE”

Center Punch Clamps

Available in 201 Stainless Steel or heat treated galvanized carbon steel. Locked with a T300 or S38 center punch tool, ensuring a strong powerful lock for reliable and consistent clamping. Both 201 Stainless Steel and galvanized carbon steel have 201 Stainless Steel buckles to provide maximum locking strength. Thickness: .025” (.635mm)



Type 201 Stainless Steel Part No.	Part Number	Clamp ID		Band Width		Pkg Qty	Weight	
		Inches	mm	Inches	mm		Lbs	Kg
3BCP3S	3BCP3	13/16	20	3/8	9.5	100	3.6	1.6
3BCP311S	3BCP311	1-3/8	35	3/8	9.5	100	4.6	2.1
3BCP4S	3BCP4	1	25	5/8	16	100	8.3	3.8
3BCP5S	3BCP5	1-1/4	32	5/8	16	100	8.7	4.0
3BCP6S	3BCP6	1-1/2	38	5/8	16	100	9.7	4.4
3BCP7S	3BCP7	1-3/4	44	5/8	16	100	10.6	4.8
3BCP8S	3BCP8	2	51	5/8	16	100	11.5	5.2
3BCP9S	3BCP9	2-1/4	57	5/8	16	100	12.6	5.7
3BCP10S	3BCP10	2-1/2	64	5/8	16	50	6.8	3.1
3BCP11S	3BCP11	2-3/4	70	5/8	16	50	7.3	3.3
3BCP12S	3BCP12	3	76	5/8	16	50	7.7	3.5
3BCP14S	3BCP14	3-1/2	89	5/8	16	50	8.7	4.0
3BCP16S	3BCP16	4	102	5/8	16	25	4.9	2.2
3BCP18S	3BCP18	4-1/2	114	5/8	16	25	5.5	2.5
3BCP20S	3BCP20	5	127	5/8	16	25	5.9	2.7
3BCP24S	3BCP24	6	152	5/8	16	25	6.8	3.1
3BCP28S	3BCP28	7	178	5/8	16	25	7.4	3.4
3BCP32S	3BCP32	8	203	5/8	16	25	8.2	3.7

Bold Text not normally APG stock item. Special Order.

BAND-IT® Scru-Seal Clamps



A screw driver is the only tool needed to tension these clamps. 3/8" or 1/2" wide Stainless Steel band is used single or double wrapped, cut as required from the 100' roll. Scru-Seal® clamps with slotted hex can be used around objects as small as 2" in diameter. Instructions for use are on the back side of the carton. (See Valustrap Band to order band separately).

All Stainless Part Number	Description	Pkg Qty	Weight	
			Lbs	Kg
3BM210	25 ea. Scru-Seals, racks, 100' (30.3M) 3/8" (9.53mm) Band	1 set	4.3	1.9
3BM211	Scru-Seal seals and racks	10 ea	.7	.3

BAND-IT® Ultra-Lok® Clamps



Used with the Band-It® UL9000 Electric Installation Tool.

Clamp I.D.		Type 201-1/4" Stainless Steel Part No.	Pkg Qty	Weight	
Inches	mm			Lbs	Kg
Band Width 3/4" (19.1mm) x Band Thickness .030" (.76mm)					
2	50.8	3BUL227	100	14.9	6.8
2-3/4	69.9	3BUL210	50	9.2	4.2
3	76.2	3BUL211	50	9.7	4.4
3-1/2	88.9	3BUL212	25	10.8	4.9
4	101.6	3BUL213	25	6.1	2.8
4-1/2	114.3	3BUL214	25	6.7	3.0
5	127.0	3BUL215	25	7.2	3.3
5-1/2	139.7	3BUL270	25	7.3	3.3
6	152.4	3BUL216	25	8.2	3.7
6-1/2	165.1	3BUL217	25	10.2	4.6
7	177.8	3BUL218	25	10.6	4.8
8	203.2	3BUL219	25	11.0	5.0
9	228.6	3BUL228	10	5.5	2.5



Need brass swing check valves? They are on the shelf at APG in seven sizes from 1/2" through 3" inch – ready for same or next day shipment.

Smooth I.D. Clamping Products

Tie-Lok® Ties

Strong, safe, low profile, permanent single wrap ties. Fireproof, resistant to corrosion, UV light and extreme temperatures.



Type 304 Stainless Steel Part No.	Type 316 Stainless Steel Part No.	For Bundle Diameter of		Width		Length		Weight	
		Inches	mm	Inches	mm	Inches	mm	Lbs	Kg
3BAS211	3BAS411	2	51	.25	6.35	10	254	1.2	.54
3BAS212	3BAS412	4	101	.25	6.35	16.5	419	1.8	.86
3BAS213	3BAS413	6	152	.25	6.35	22.5	572	2.6	1.17
3BAS214	3BAS414	8	203	.25	6.35	29	737	3.3	1.50
3BAS215	3BAS415	10	254	.25	6.35	35	889	3.9	1.79

Bold Text not normally APG stock item. Special Order.

I.D. Tagging System

I.D. Tags

Identify your cable bundles or hose assemblies with permanent, Type 304 or Type 316 Stainless Steel imprinted tags applied with Tie-Lok® Ties

Type 304 Stainless Steel Part No.	Type 316 Stainless Steel Part No.	Thickness		Width		Length		Weight	
		Inches	mm	Inches	mm	Inches	mm	Inches	mm
3BID100	3BID440	.10	.254	0.75	19.05	2.0	51	0.5	.22
3BID101	3BID441	.15	.381	1.50	38.10	2.5	63	1.2	.55
3BID102	3BID442	.15	.381	0.75	19.05	3.5	89	0.8	.36



Handy, waterproof, plastic packaging for BANDIT® Band. Color-coded for easy identification. Easy to refill from standard cartons. Convenient carrying handle. See-through design shows remaining band. Winding mandrel provides quick, no-waste coiling and recoiling.

BAND-IT® Totes

Part No.	Description	Weight	
		Lbs	Kg
BAND-IT® Totes (complete with band)			
3BC203Y	3/8" Band in Yellow Tote	3.62	1.6
3BC204B	1/2" Band in Blue Tote	5.56	2.5
3BC205G	5/8" Band in Green Tote	6.85	3.1
3BC206R	3/4" Band in Red Tote	8.16	3.7



1/4" band not available in Totes

Bold Text not normally APG stock items. Special order.



Band-It® Jr. Smooth I.D. Clamps

BAND-IT Jr.® Smooth I.D. clamps were developed to prevent leak problems on industrial hose made of stiffer, thinner thermoplastics. Manufactured in a wide variety of widths, sizes, and materials that provide a uniform, gap-free, inside diameter with the same strong holding power of the standard BAND-IT Jr.® clamp. APG normally stocks the Type 201 Stainless Steel. Type 316 Stainless Steel and Galvanized Carbon Steel are also available by special order.



NOTE:
BAND-IT®
Manufactures other
products not normally
stocked by APG that
are available by
Special Order.
Please inquire.

Clamp I.D.		Type 201 Stainless Steel Part No.	Pkg Qty	Weight	
Inches	mm			Lbs	Kg
Band Width 1/4" (6.4mm) x Band Thickness .020" (.51mm)					
3/4	19.1	3BJS240	100	2.0	0.9
1	25.4	3BJS242	100	2.1	1.0
1-3/8	34.9	3BJS241	100	2.5	1.1
1-1/2	38.1	3BJS252	100	2.6	1.2
2	50.8	3BJS253	100	3.2	1.5
2-1/2	63.5	3BJS220	100	3.7	1.7
2-3/4	69.9	3BJS256	100	3.8	1.7
3	76.2	3BJS244	100	4.2	1.9
3-1/2	88.9	3BJS257	100	4.6	2.1
4	101.6	3BJS258	100	5.3	2.4
4-1/2	114.3	3BJS259	100	5.7	2.6
Band Width 3/8" (9.5mm) x Band Thickness .025" (.64mm)					
13/16	20.6	3BJS201	100	3.6	1.6
1	25.4	3BJS243	100	3.9	1.8
1-3/8	34.9	3BJS202	100	5.0	2.3
2	50.8	3BJS245	100	5.9	2.7
2-1/2	63.5	3BJS221	100	6.8	3.1
3	76.2	3BJS246	100	7.5	3.4
3-1/4	82.6	3BJS255	100	8.6	3.9
4	101.6	3BJS248	100	9.5	4.3
Band Width 1/2" (12.7mm) x Band Thickness .030" (.76mm)					
1	25.4	3BJS203	100	6.5	3.0
1-1/4	31.8	3BJS204	100	7.2	3.3
1-1/2	38.1	3BJS231	100	8.1	3.7
1-3/4	44.5	3BJS236	100	8.7	4.0
2	50.8	3BJS237	100	9.4	4.3
2-1/2	63.5	3BJS233	100	10.8	4.9
2-3/4	69.9	3BJS230	100	11.3	5.1
3	76.2	3BJS234	100	12.2	5.5
3-1/2	88.9	3BJS247	100	13.6	6.2
4	101.6	3BJS249	100	14.9	6.8
Band Width 5/8" (15.9mm) x Band Thickness .030" (.76mm)					
1-1/2	38.1	3BJS205	100	10.4	4.7
1-3/4	44.5	3BJS206	100	11.3	5.1
2	50.8	3BJS207	100	12.2	5.5
2-1/4	57.2	3BJS208	100	13.3	6.0
2-1/2	63.5	3BJS209	100	13.9	6.3
Band Width 3/4" (19.1mm) x Band Thickness .030" (.76mm)					
2	50.8	3BJS227	100	14.9	6.8
2-3/4	69.9	3BJS210	50	9.2	4.2
3	76.2	3BJS211	50	9.7	4.4
3-1/2	88.9	3BJS212	50	10.8	4.9
4	101.6	3BJS213	25	6.1	2.8
4-1/2	114.3	3BJS214	25	6.7	3.0
5	127.0	3BJS215	25	7.2	3.3
5-1/4	133.4	3BJS270	25	7.3	3.3
6	152.4	3BJS216	25	8.2	3.7
7	177.8	3BJS218	25	10.2	4.6
8	203.2	3BJS219	25	11.0	5.0

Bold Text not normally APG stock item. Special Order.



Have you been passing by opportunities to provide Mil-Spec cam and groove couplings to your customers? Ever-TITE® brass and aluminum cam and groove couplings fulfill the Mil-Spec requirements, and APG can deliver!

Band-IT® Tools

A drop forged tool with tensioning capability of over 2,400 lbs., and a built-in cutter. Features include: spring loader gripper lever for improved band tensioning, friction held cutoff lever with plastic grip for easier operation, permanent lubrication on the tension screw to extend tool life and speed clamping, zinc plated black chromate finish to provide superior corrosion resistance, spin handle retaining ring to keep parts intact. The BAND-IT® Tool is used to apply BAND-IT® Bands and Buckles, strapping, and Free-End clamps.

Part No.	Description
3BC001	The BAND-IT® Tool Pkg Qty 1 Weight 4.4 lbs. (2.0 Kg)

Must be used to apply heavy duty Giant clamps. Measures 16-1/2" in length. Designed to pull up to 6,000 lbs.

Part No.	Description
3BG402	Giant Tool Pkg Qty 1 Weight 11.7 lbs. (5.3 Kg)

Used to apply BAND-IT Jr.® Preformed Clamps and BAND-IT Jr.® Smooth I.D. Clamps.

Part No.	Description
3BC002	The Jr.® Tool Pkg Qty 1 Weight 5.7 lbs (2.6 Kg)

Use with the BAND-IT® Tool for Jr. Preformed and Smooth I.D. Clamps.

Part No.	Description
3BJ001	Jr. Adapter Pkg Qty 1 Weight 1.4 lbs (.6 Kg)

The BAND-IT® Tool



Giant Tool



The Jr.® Tool



Jr. Adapter



Heavy Duty Jr. Adapter



Use with the BAND-IT® Tool for Jr. Preformed and Smooth I.D. Clamps.
Also for use in portable applications.

Part No.	Description
3BJ050	Heavy Duty Jr. Adapter Pkg Qty 1 Weight 1.7 lbs (.8 Kg)

Bantam Tool C075



Designed for use in light duty banding applications: such as insulation, cable bundling, and sign hanging. Compact, lightweight, ratchet action tool with a built-in cutter. Designed for easy loading and removing of material. Zinc plated for corrosion resistance. Tension release levers for situations requiring repositioning of the band after tensioning has begun. With the unique 3-way handle, the Bantam Tool can be used in the pistol grip position for one-handed, or in the other positions for two-handed tensioning. It is especially useful in tight areas with minimal access such as in cable bundling aboard ships.

Part No.	Description
3BC075	Bantam Tool C075 Pkg Qty 1 Weight 2.6 lbs (1.2 Kg)

Bantam Strapping Tool C085



A less expensive strapping tool for light duty strapping applications on flat surfaces with minimal access. Designed for quick take-up and tensioning. Self-contained, requiring no extra tools to complete the clamp.

Part No.	Description
3BC085	Bantam Strapping Tool C085 Pkg Qty 1 Weight 2.3 lbs (1.0 Kg)

Pok-It II Tool



Lightweight pocket size tool for use with 1/4" - 3/8" width band, for Ear-Lokt, Scru-Lokt, BANDIT Jr.® preformed Clamps, and Free-End Clamps. Applies tension and has a built-in cutter.

Part No.	Description
3BJ020	Pok-It II Tool Pkg Qty 1 Weight 1.1 lbs (.5 Kg)



Don't forget – APG has a large selection of Brass Hydrant Adapters and Hex Nipples – including the very popular Swivel Adapters. All on the shelf, ready for same or next day shipment

Ratchet action tensioning tools for applying Center Punch and Center Punch Open-End Clamps with a center punch lock.

Part No.	Description
3BT300	For 5/8" Wide Clamps Pkg Qty 1 Weight 3.15 lbs (1.5 Kg)
3BS38	For 3/8" and 5/8" Wide Clamps Pkg Qty 1 Weight 1.1 lbs (.5 Kg)

Center Punch Tools



Ultra-Lok® Band Clamping System

The fully portable and powerful UL9000 is used to apply the patented Smooth I.D. Ultra-Lok® Clamps. Features include: speed/torque control on tool for consistent repeatability on hose couplings, impact/drill selector, actuator switch, preset torque indicator light, .094 thick buckle and .030 thick 1/4" hard band provides extra strength and reliability, and a greater clamping force - 2-3 times stronger than conventional clamps. Patented Ultra-Lok® Buckles can also be used with BAND-IT® 3/4" Stainless Steel.

Part No.	Description
3BUL9000	Applies Ultra-Lok® Band Clamps Pkg Qty 1 Weight 18.3 lbs (8.4 Kg)

Not normally an APG stock item. Special order.



Tie-Lok II Tool®

A patented, lightweight, pocket size hand tool which quickly and easily applies smooth I.D. Tie-Lok Ties.

Part No.	Description
3BA920	Tie-Lok II Pkg Qty 1 Weight .94 lbs (.43 Kg)



BAND-IT® Full Flow Hose Nipples

For concrete placement hose, plaster spray, grouting hose, and other applications needing full flow and reduced abrasion within the nipple. Heat treated for longer life. Complete with tie strip.

Part No.	Hose I.D.		End	No. Clamps per Fittings		Weight	
	Inch-es	mm		Ear-Lokt Double Wrapped	Giant Double Wrapped	Lbs	Kg
3BH750	1-1/2	38.1	NPT	4	—	1.3	.6
3BH755	2	50.8	Grooved	4	—	1.3	.6
3BH757	2	50.8	NPT	4	—	1.7	.8

Bold Text not normally APG stock item. Special Order.



APG Worm Gear Clamps

All Stainless Steel



3WGA 3WGB

APG Worm Gear Clamps offer an extremely cost effective alternative for a variety of reasons. First — they offer All Stainless Steel construction at a price that is cheaper than most competitive brands with carbon steel components. Second — APG market research determined that sales of worm gear clamps with 1/2" widths were predominately in the smaller diameter sizes, and sales of clamps with 9/16" widths were predominately in the larger diameter sizes. Consequently, as can be seen in the chart below, APG smaller diameter clamps have 1/2" widths, and larger diameter clamps have 9/16" widths. Additionally, the 9/16" clamps have a minimum range of 2-1/2". This allows these clamps to be utilized in ranges that overlap with 1/2" clamps (as can be seen in the highlighted portion of the chart). Hence, the end user has the ability to select a width of 1/2" or 9/16" in this mid-range. These factors combine to eliminate the need for an inventory that includes clamps with carbon steel components as well as clamps that are Stainless Steel (stainless being preferable if the price is right). Also, the need for an inventory that includes clamps with widths of both 1/2" and 9/16". This allows an inventory with one worm gear clamp style as opposed to four styles. All clamps are stamped with the range in both millimeters and includes, the APG part number, and the APG logo.

APG Worm Gear Clamps

Screw: 5/16" Hex Head; 304 Stainless Steel

Band and Housing: 304 Stainless Steel

Band Width: 3WGA Series 1/2" — 3WGB Series 9/16"

Part No.	Band Width	Range	
		(mm)	(Inches)
3WGA06	1/2	10 - 22	3/8 - 7/8
3WGA08	1/2"	11 - 25	7/16 - 1
3WGA10	1/2"	13 - 27	1/2 - 1-1/16
3WGA12	1/2"	13 - 32	1/2 - 1-1/4
3WGA16	1/2"	19 - 38	3/4 - 1-1/2
3WGA20	1/2"	19 - 44	3/4 - 1-3/4
3WGA24	1/2"	25 - 50	1 - 2
3WGA28	1/2"	32 - 57	1-1/4 - 2-1/4
3WGA32	1/2"	38 - 64	1-1/2 - 2-1/2
3WGA36	1/2"	22 - 70	7/8 - 2-3/4
3WGA40	1/2"	29 - 76	1-1/8 - 3
3WGA44	1/2"	35 - 82	1-3/8 - 3-1/4
3WGA48	1/2"	41 - 89	1-5/8 - 3-1/2
3WGA52	1/2"	48 - 95	1-7/8 - 3-3/4
3WGA56	1/2"	54 - 102	2-1/8 - 4
3WGA64	1/2"	67 - 114	2-5/8 - 4-1/2
3WGA72	1/2"	79 - 127	3-1/8 - 5
3WGA80	1/2"	92 - 140	3-5/8 - 5-1/2
3WGA88	1/2"	108 - 152	4-1/4 - 6
3WGA96	1/2"	121 - 165	4-3/4 - 6-1/2
3WGA104	1/2"	102 - 178	4 - 7
3WGB128	9/16"	64 - 216	2-1/2 - 8-1/2
3WGB140	9/16"	64 - 235	2-1/2 - 9-1/4
3WGB152	9/16"	64 - 254	2-1/2 - 10
3WGB164	9/16"	64 - 273	2-1/2 - 10-3/4
3WGB176	9/16"	64 - 292	2-1/2 - 11-1/2
3WGB188	9/16"	64 - 311	2-1/2 - 12-1/4



APG brand worm gear clamps are all 316 Stainless Steel and cost less than competitive brands with carbon steel screws and housings. So what's not to like?

Ideal Clamps

IDEAL manufactures a broad line of standard worm drive and specialty hose clamps designed to satisfy a wide range of fastening applications. All or part Stainless Steel construction is offered. Full size worm drive clamps have a 9/16" band which provides 12-1/2% more sealing surface than conventional 1/2" bands. Clamps are available with 1/4", 5/16", or 3/8" hex-head and safety collared screws, in stainless or zinc-plated, dichromated, carbon steel. The completely mechanical design locks the one piece housing directly to the band using the full strength of the material to provide maximum anti-shear protection. There are no spot welds to rupture under stress or corrosion, and a one piece housing cannot come apart under high loading.

Full Size Worm Gear Clamps

HY-GEAR

The industry standard. Wide range of applications, from simple home and auto repair to heavy duty industrial applications.



Hy-Gear 50 Series

IDEAL's most popular full size clamp. Screw: 5/16" hex-head. Zinc plated, yellow dichromate, carbon steel. Band and housing: 9/16" wide. Stainless Steel.

Hy-Gear 63 Series

A marine grade clamp for boating applications and other corrosive environments. High nickel alloy meets the demands of inground and marine use. Screw: 5/16" hex-head. Corrosion resistant 300 grade Stainless Steel. Band and housing: 9/16" wide. 300 grade Stainless Steel.

Hy-Gear 64 Series

All Stainless Steel construction especially suited to industrial applications. Screw: 3/8" hex-head. 410 grade Stainless Steel. Band and housing: 9/16" wide. 300 grade Stainless Steel.

Hy-Gear 68 Series

All Stainless Steel construction especially suited to industrial applications. Screw: 5/16" hex-head. 410 grade Stainless Steel. Band and housing 9/16" wide. 300 grade Stainless Steel.

The choice of professional mechanics. Particularly helpful in hard to reach areas. An exclusive safety collared deep slotted screw design prevents screw drivers from slipping and puncturing the hose wall. Can be installed with a screw driver, nut driver, or socket wrench.

Combo-Hex

54 Series



Screw: 3/8" safety collared hexhead. Zinc plated yellow dichromate, carbon steel. Band and housing: 9/16" wide. Stainless Steel.

Ideal Part No. *					Clamp Diameters				SAE Size No.	Fits Hose I.D. (Inches)
50 Series	54 Series	63 Series	64 Series	68 Series	Inches		Millimeters			
					Min	Max	Min	Max		
5006	5406	6306	6406	6806	3/8	7/8	10	22	6	5/16 to 3/8
5008	5408	6308	6408	6808	7/16	1	11	25	8	5/16 x 1/2
5010	5410	6310	6410	6810	1/2	1-1/16	13	27	10	3/8 x 5/8
5012	5412	6312	6412	6812	1/2	1-1/4	13	32	12	3/8 to 3/4
5016	5416	6316	6416	6816	3/4	1-1/2	19	38	16	3/4 to 7/8
5020	5420	6320	6420	6820	3/4	1-3/4	19	44	20	3/4 to 1-1/8
5024	5424	6324	6424	6824	1	2	26	50	24	7/8 to 1-3/8
5028	5428	6328	6428	6828	1-5/16	2-1/4	34	57	28	1-1/4 to 1-5/8
5032	5432	6332	6432	6832	1-9/16	2-1/2	40	64	32	1-1/2 to 1-7/8
5036	5436	6336	6436	6836	7/8	2-3/4	23	70	36	3/4 to 2
5040	5440	6340	6440	6840	1-1/8	3	29	76	40	1 to 2-1/4
5044	5444	6344	6444	6844	1-5/16	3-1/4	34	82	44	1-1/4 to 2-1/2
5048	5448	6348	6448	6848	1-5/8	3-1/2	42	90	48	1-1/2 to 2-3/4
5052	5452	6352	6452	6852	1-7/8	3-3/4	48	95	52	1-3/4 to 3
5056	5456	6356	6456	6856	2-1/8	4	54	100	56	2 to 3
5064	—	6364	6464	6864	2-5/8	4-1/2	67	114	64	2-1/2 to 3-1/2
5072	—	6372	6472	6872	3-1/8	5	80	127	72	3 to 4
5080	—	6380	6480	6880	3-5/8	5-1/2	92	140	80	3-1/2 to 4-1/2
5088	—	6388	6488	6888	4-1/4	6	108	153	88	3-1/2 to 5-1/2
5096	—	6396	6496	6896	4-3/4	6-1/2	121	165	96	4-1/2 to 6
50104	—	63104	64104	68104	5	7	102	178	104	3-1/2 to 6-1/2
—	—	—	—	68116	5-7/8	7-3/4	149	197	116	5-1/2 to 7-1/4
—	—	63128	—	—	2-1/2	8-1/2	64	216	128	2 to 7-1/2
—	—	63140	—	—	2-1/2	9-1/4	64	235	140	2 to 8-3/4
—	—	63152	—	—	2-1/2	10	64	254	152	2 to 9-1/2
—	—	63164	—	—	2-1/2	10-3/4	64	273	164	2 to 10
—	—	63176	—	—	2-1/2	11-1/2	64	292	176	2 min.
—	—	63188	—	—	2-1/2	12-1/4	64	311	188	2 min.
—	—	63208	—	—	2-1/2	13-1/4	64	337	208	2 min.
—	—	63224	—	—	2-1/2	14-1/2	64	368	224	2 min.
—	—	63263	—	—	2-1/2	15-1/4	64	387	236	2 min.
—	—	63248	—	—	2-1/2	16	64	406	248	2 min.

Bold Text not normally APG stock item. Special Order.

Small Diameter Clamps

Tiny, tough, and precision engineered for use in small hose applications. The 5/16" band and low profile housing makes them easy to install in confined areas.



Micro-Gear 62P Series

Micro-Gear 62M Series

Screw: 1/4" hexhead.
Zinc-plated, yellow dichromate, carbon steel.
Band and housing: 5/16" Stainless Steel

Screw: 1/4" hex-head.
300 Series marine grade Stainless Steel.
Band and housing: 5/16" 300 Series Marine grade Stainless Steel.

Ideal Part No. *		Clamp Diameters				SAE Size No.	Fits Hose I.D. (Inches)
62P Series	62M Series	Inches		Millimeters			
		Min	Max	Min	Max		
6202	62602	1/4	5/8	6	16	4	1/8 to 5/16
6203	62606	5/16	7/8	8	22	6	1/4 to 7/16
62P08	62M08	1/2	1	12	25	8	5/16 to 1/2
62P12	62M12	5/8	1-1/4	16	32	12	5/8 to 3/4
62P16	62M16	5/8	1-1/2	16	38	16	3/4 to 1
62P20	62M20	3/4	1-3/4	19	45	20	1 to 1-1/4
62P24	62M24	1	2	25	50	24	7/8 to 1-3/8
62P30	62M30	1-3/8	2-3/8	35	60	30	1-1/4 to 1-7/8
62P36	62M36	1-3/4	2-3/4	45	70	36	1-1/2 to 2
62P44	62M44	2-1/4	3-1/4	58	82	44	1-5/8 to 2-1/2
62P48	62M48	2-1/2	3-1/2	64	90	48	1-7/8 to 2-3/4
62P56	62M56	3	4	77	100	56	2-1/4 to 3

Add "3I" prefix for APG part numbers. Bold areas not normally APG stock items. Special order.

1/2" Band Clamps

1/2" Band

Suitable for most common home and automotive applications.



57 Series

67-1 Series

Screw: 5/16" hex-head.
Zinc plated, yellow dichromate, carbon steel.
Band and housing: 1/2" Stainless Steel.

Screw: 5/16" hex-head.
410 grade Stainless Steel.
Band and housing: 1/2" Stainless Steel.

Ideal Part No. *		Clamp Diameters				SAE Size No.	Fits Hose I.D. (Inches)
57 Series	67-1 Series	Inches		Millimeters			
		Min	Max	Min	Max		
5706	6706-1	3/8	7/8	10	22	6	5/16 to 3/8
5708	6708-1	7/16	1	11	25	8	5/16 to 1/2
5710	6710-1	1/2	1-1/16	13	27	10	3/8 to 5/8
5712	6712-1	1/2	1-1/4	13	32	12	3/8 to 3/4
5716	6716-1	3/4	1-1/2	19	38	16	3/4 to 7/8
5720	6720-1	3/4	1-3/4	19	44	20	3/4 to 1-1/8
5724	6724-1	1	2	26	50	24	7/8 to 1-3/8
5728	6728-1	1-5/16	2-1/4	34	57	28	1-1/4 to 1-5/8
5732	6732-1	1-9/16	2-1/2	40	64	32	1-1/2 to 1-7/8
5736	6736-1	7/8	2-3/4	23	70	36	3/4 to 2
5740	6740-1	1-1/8	3	29	76	40	1 to 2-1/4
5744	6744-1	1-5/16	3-1/4	34	82	44	1-1/4 to 2-1/2
5748	6748-1	1-5/8	3-1/2	42	90	48	1-1/2 to 2-3/4
5752	6752-1	1-7/8	3-3/4	48	95	52	1-1/4 to 3
5756	6756-1	2-1/8	4	54	100	56	2 to 3-1/2
5764	6764-1	2-5/8	4-1/2	67	114	64	2-1/2 to 4
5772	6772-1	3-1/8	5	80	127	72	3 to 4-1/2
5780	6780-1	3-5/8	5-1/2	92	140	80	3-1/2 to 5
5788	6788-1	4-1/4	6	108	152	88	3-1/2 to 5-1/2
5796	6796-1	4-3/4	6-1/2	121	165	96	4-1/2 to 6
57104	67104-1	4	7	102	178	104	3-1/2 to 6-1/2

Add "3I" prefix for APG part numbers.



Don't let the pressure get to you! With over 150 different pressure gauges in our inventory, APG can help you and your customers manage the pressure. Dry, liquid filled, black steel or Stainless Steel – they are all on the shelf.

Quick Release Clamps

Snaplock

For installation in “closed” systems where the clamp must be disengaged to be applied. The swivel-action locking of screw to band make both installation and removal fast and easy.

Ideal Part No. *		Clamp Diameters				SAE Size No.	Fits Hose I.D. (Inches)
56 Series	58 Series	Inches		Millimeters			
		Min	Max	Min	Max		
5620	—	3/4	1-3/4	19	44	20	3/4 to 1-1/8
5628	5828	1	2-1/4	26	57	28	7/8 to 1-5/8
5656	—	1	4	26	100	56	7/8 to 3
5672	5872	2	5	51	130	72	1-1/2 to 4
5688	5888	2	6	51	152	88	1-1/2 to 5
56104	58104	2	7	51	176	104	1-1/2 to 6
56128	58128	2-5/16	8-1/2	60	215	128	1-3/4 to 8-1/2
56152	58152	2-5/16	10	60	254	152	1-3/4 to 9-1/2
56188	58188	2-5/16	12	60	311	188	1-3/4 to 11-1/2
62P44	62M44	2-1/4	3-1/4	58	82	44	1-5/8 to 2-1/2
62P48	62M48	2-1/2	3-1/2	64	90	48	1-7/8 to 2-3/4
62P56	62M56	3	4	77	100	56	2-1/4 to 3

Add “3I” prefix for APG part numbers.



Snaplock 56 Series

Snaplock 58 Series

Screw: 5/16" hex-head.
Zinc plated, yellow dichromate, carbon steel.
Band and housing: 9/16" Stainless Steel.
Bridge: Zinc plated, yellow dichromate, carbon steel.

Screw: 3/8" hex-head.
410 grade Stainless Steel.
Band and housing: 9/16" Stainless Steel.
Bridge: Stainless Steel.

Lined clamps

Specifically designed for use with silicone rubber and other soft hose applications. The extended band or liner protects the hose surface and prevents it from extruding or shearing through the band notches as the clamp is tightened.

IDEAL Part No.*	Clamp Diameters				SAE Size No.	Fits Hose I.D. (Inches)
	Inches		Millimeters			
Marine Grade Lined Clamp	Min	Max	Min	Max		
6708M	1/2	1	14	26	8	1/2
6710M	11/16	1-1/8	17	29	10	5/8
6712M	11/16	1-1/4	17	32	12	3/4
6716M	3/4	1-1/2	20	38	16	7/8
6720M	13/16	1-3/4	21	45	20	5/8 to 1-1/8
6724M	1-1/16	2	27	51	24	7/8 to 1-3/8
6728M	1-1/4	2-1/4	33	57	28	1-1/4 to 1-5/8
6732M	1-9/16	2-1/2	39	64	32	1-1/2 to 1-7/8
6736M	1-13/16	2-3/4	46	70	36	1-5/8 to 2
6740M	2-1/16	3	52	76	40	2 to 2-1/4
6744M	2-5/16	3-1/4	58	83	44	2-1/4 to 2-1/2
6748M	2-9/16	3-1/2	65	90	48	2-1/2 to 2-3/4
6752M	2-13/16	3-3/4	71	95	52	2-3/4 to 3
6756M	3-1/16	4	78	102	56	3
6760M	3-5/16	4-1/4	84	108	60	3-1/4
6764M	3-9/16	4-1/2	90	114	64	3-1/2
6772M	4-1/16	5	103	127	72	4
6788M	5-1/16	6	128	152	88	5
6796M	5-9/16	6-1/2	141	165	96	6

Add “3I” prefix for APG part numbers.



Marine Grade Lined Clamp 67 M Series

All 316 Stainless Steel construction.
Offers superior corrosion resistance.
Screw: 5/16" hex-head.
Band, liner, and housing: 1/2" wide.

Protective Sleeving

Bentley-Harris Fyrejacket®



Non-asbestos sleeving used to protect hoses and hose assemblies, tubing, piping, wires, wire assemblies, and cables from exposure up to 500°F and from molten splash. Fiberglass coated with specially compounded silicone rubber. Slides easily over all types of cables and hoses and expands readily to go over fittings and couplings. The specially formulated silicone rubber coating has excellent shedding properties and is highly resistant to a wide range of solvents and fuels.

Nominal Size I.D.	American Packing Part Number*	Nominal Size I.D.	American Packing Part Number*	Nominal Size I.D.	American Part Number*
1/4"	—	1"	3HFJ16	2-1/2"	—
5/16"	3HFJ05	1-1/8"	3HFJ18	2-5/8"	—
3/8"	—	1-1/4"	3HFJ20	2-3/4"	—
7/16"	3HFJ07	1-3/8"	—	2-7/8"	—
1/2"	3HFJ08	1-1/2"	3HFJ24	3"	—
9/16"	—	1-5/8"	—	3-1/8"	—
5/8"	—	1-3/4"	3HFJ28	3-1/4"	—
11/16"	—	1-7/8"	—	3-1/2"	—
3/4"	3HFJ12	2"	3HFJ32	3-3/4"	—
13/16"	—	2-1/8"	—	4"	—
7/8"	—	2-1/4"	—	—	—
15/16"	—	2-3/8"	—	—	—

Bentley-Harris Thermo jacket®

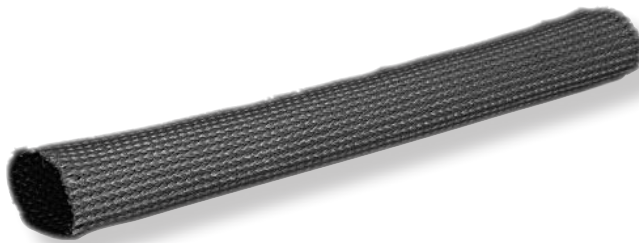

Provides excellent long-term heat protection for hoses, wire harnesses, and cables. Also protects against flame burst and molten splash, and shields workers from painful contact with hot or cold lines. Braided fiberglass with long-term heat protection up to 1000°F. Saturated to add firmness and reduce fray. Improved resistance to abrasion and flex.

Size	American Packing Part Number*	Aprox. Footage Needed to Cover 100 Ft.	Size	American Packing Part Number*	Aprox. Footage Needed to Cover 100 Ft.
1/4"	3HTJS4	100	1-3/4"	3HTJS22	111
3/8"	3HTJS6	100	2"	3HTJS22	117
1/2"	3HTJS6	100	2-1/4"	3HTJS22	128
5/8"	3HTJS10	100	2-1/2"	3HTJS44	104
3/4"	3HTJS10	115	2-3/4"	3HTJS44	109
7/8"	3HTJS10	140	3"	3HTJS44	116
1"	—	102	3-1/4"	3HTJS44	119
1-1/4"	—	108	3-1/2"	3HTJS44	128
1-3/8"	3HTJS22	100	3-3/4"	3HTJS44	139
1-1/2"	3HTJS22	106	4"	3HTJS44	151

Bold Text not normally APG Stock items. Special order.



When many people think of APG EVER-TITE® couplings, they think “Cam and Groove Couplings.” And this is great, because they are the best cam and groove values on the market. But don’t forget all the other products in our Industrial Hose Coupling Catalog.

Bentley-Harris Expando® DM



Dual-monofilament construction, smoothly blends tougher, nylon strands with customary resilient polyester strands. Excellent balance of key features including toughness, expandability, resilience, and flexibility. Used to protect the cable assemblies, hoses and wire harnesses from chafing, cutting and abrading. Open textile construction makes the products highly flexible and resistant to trapping water, heat and humidity. Should be considered wherever handling, repeated flexing, abrasion, impact or similar hazards indicate a need for a high performance protective sleeve. Ideally suited for applications in electronics, marine, vehicular and industrial environments. Temperature range: -70° to 125°C.

Nominal Size I.D.	American Packing Part Number*	Fits Diameter Range (Inches)	Weight (lbs/100 ft)	Feet Per Spool
1/4"	—	1/8" - 1/2"	0.33	1,000
3/8"	—	1/4" - 1/2"	0.77	500
1/2"	—	1/4" - 7/8"	1.10	500
3/4"	3HED12	1/2" - 1-1/4"	1.54	500
1"	3HED16	5/8" - 2"	1.98	250
1-1/4"	—	3/4" - 2-1/4"	2.09	250
1-1/2"	3HED24	7/8" - 2-1/2"	2.75	250
2"	3HED32	1-1/8" - 3"	3.52	250

*Part numbers shown for normally stocked sizes. Others available by special order.

CONTACT YOUR APG
REGIONAL SALESMAN TODAY!



CALL US



EMAIL



FAX



WALK-IN

“AMERICA’S MOST RESPONSIVE WAREHOUSE”



Material Recommendations

Fluid	Aluminum	Cast Brass	Forged Brass	Ductile Iron	Stainless Steel	Polypropylene	Gasket	Fluid	Aluminum	Cast Brass	Forged Brass	Ductile Iron	Stainless Steel	Polypropylene	Gasket
ACETIC ACID	X	—	—	—	X	X	BENTV	COPPER CHLORIDE – DRY	—	—	—	X	—	X	BENTV
ACETIC ANHYDRIDE	X	—	—	—	X	X	BNT	COPPER SULFATE	—	—	—	—	X	X	BENTV
ACETONE	X	—	—	X	X	X	BET	COPPERIZED SUPER COMPOUND	—	—	—	—	—	X	B
ACETYLENE–DRY	X	—	—	X	X	—	BENTV	CORN OIL	—	—	—	—	X	X	BNTV
AGRICULTURAL LIME SOLUTIONS	—	—	—	X	X	X	B	COTTONSEED OIL	X	—	—	—	X	X	BNTV
AIR	X	X	X	X	X	X	B	CREOSOTE	X	X	X	X	X	—	V
ALCOHOL – AMYL	—	X	X	X	X	X	BENTV	CRESYLIC ACID	X	X	X	X	X	—	ETV
ALCOHOL – BUTYL	X	X	X	X	X	X	BENTV	CYCLOHEXANE	X	X	X	X	X	—	BTV
ALCOHOL – ETHYL	—	X	X	X	X	X	BENTV	DETERGENTS	—	—	—	—	X	X	BENTV
ALCOHOL – ISOPROPYL	X	X	X	X	X	X	BENTV	DEVELOPER SOLUTIONS	—	—	—	—	—	X	B
ALCOHOL – METHYL	—	X	X	X	X	X	BENT	DEXTROSE	X	—	—	—	X	X	BENTV
ALUMINUM CHLORIDE	—	—	—	—	—	X	BENTV	DIESEL FUELS	X	X	X	X	X	X	BTV
ALUMINUM FLUORIDE, 20%	X	X	X	—	—	—	BENTV	DIETHYL SEBACATE	—	—	—	X	—	—	N
ALUMINUM NITRATE	—	—	—	—	X	X	BENTV	DISODIUM PHOSPHATE	—	—	—	—	—	X	BENT
ALUMINUM POTASSIUM SULFATE	X	—	—	—	X	X	BENTV	DOWTHERM (DIPHENYL)	—	—	—	—	—	—	V
ALUMINUM SULFATE	—	—	—	—	X	X	BENTV	ETHANOLAMINE	X	—	—	X	X	X	BNT
AMMONIA, ANHYDROUS (DRY)	X	—	—	—	X	X	BENT	ETHER	X	X	X	—	X	—	BT
AMMONIA, SOLUTIONS	X	—	—	—	X	X	BN	ETHYL ACETATE	—	—	—	X	X	X	ET
AMMONIUM CHLORIDE – DRY	—	—	—	—	—	X	BENTV	ETHYL CHLORIDE – DRY	X	X	X	—	X	—	BETV
AMMONIUM HYDROXIDE	X	—	—	—	X	X	BENTV	ETHYLENE	—	X	X	X	X	—	B
AMMONIUM NITRATE	X	—	—	X	X	X	BENT	ETHYLENE DICHLORIDE – DRY	X	X	X	X	X	—	TV
AMMONIUM PHOSPHATE	—	—	—	—	X	X	BENTV	ETHYLENE GLYCOL	X	X	X	X	X	X	BENTV
MONO – BASIC	—	—	—	—	X	X	B	FATTY ACIDS	—	—	—	—	X	X	BNTV
DI-BASIC OR TRI-BASIC	X	—	—	—	X	X	B	FERRIC CHLORIDE	—	—	—	—	—	X	BENTV
AMMONIUM SULFATE	—	—	—	X	X	X	BENTV	FERRIC HYDROXIDE	—	—	—	—	—	X	BENTV
ANILINE	—	—	—	—	X	X	ETV	FERRIC NITRATE	—	—	—	—	X	X	BENTV
ARSENIC ACID	—	—	—	—	X	X	BENTV	FERRIC SULFATE	—	—	—	—	X	X	BENTV
ASPHALT	—	X	X	X	X	—	TV	FLUOBURIC ACID	—	—	—	—	X	X	BENTV
BARIUM CHLORIDE	—	—	—	—	X	X	BENTV	FORMALDEHYDE, 40%	X	—	—	—	X	X	ENT
BARIUM HYDROXIDE	—	—	—	—	X	X	BENTV	FORMALIN	X	—	—	—	X	X	N
BARIUM SULFIDE	—	—	—	X	X	X	BENTV	FORMIC ACID	X	—	—	—	X	X	ENT
BASIC SLAG	—	—	—	X	—	X	B	FREON	X	—	—	X	X	X	BNTV
BEER	X	X	X	—	X	X	BENTV	FRUIT JUICES: GRAPEFRUIT	—	—	—	—	X	X	BNTV
BENZENE/BENZOL	X	X	X	X	X	—	TV	LEMON	—	—	—	—	X	X	BNTV
BENZINE	X	X	X	X	X	—	B	PINEAPPLE	—	—	—	—	X	X	BNTV
BLACK LIQUOR (PAPER INDUSTRY)	—	—	—	X	—	X	BENTV	FURFURAL	X	X	X	X	X	—	ENT
BLEACH (12.5% CHLORINE)	—	—	—	—	—	X	ENTV	GASOLINE – REFINED	X	X	X	X	X	—	BNTV
BORAX	—	—	—	X	X	X	BENSTV	GASOLINE – SOUR	X	—	—	—	X	—	BNTV
BORIC ACID	X	—	—	—	X	X	BENTV	GELATIN	X	—	—	—	X	X	BENTV
BRINE	—	—	—	—	X	X	BENTV	GLUCOSE	X	—	—	—	X	X	BENTV
BROMIC ACID	—	—	—	—	—	X	ENTV	GLUE	X	X	X	X	X	X	BENTV
BURNT LIME	X	X	X	X	X	X	B	GLYCERINE	X	X	X	X	X	X	BENTV
BUTANE	X	X	X	X	X	—	BTV	GLYCOL	—	—	—	—	—	X	BENTV
BUTADIENE	X	X	X	—	X	—	BNSTV	GREEN LIQUOR (PAPER INDUSTRY)	—	—	—	—	—	X	BENTV
BUTYL ACETATE – DRY	X	X	X	X	X	—	ET	HEXANE	X	X	X	X	X	—	BNTV
BUTYL STEARATE	X	X	X	X	X	—	B	HYDROBROMIC ACID	—	—	—	—	—	X	ETV
BUTYLENE	X	X	X	X	X	—	B	HYDROBROMIC ACID, 40%	—	—	—	—	—	X	ETV
CADMIUM CYANIDE	—	—	—	—	—	X	B	HYDROBROMIC ACID, 100%	—	—	—	—	—	X	V
CALCIUM ACETATE	—	X	X	—	X	X	BE	HYDROCHLORIC ACID	—	—	—	—	—	X	ENTV
CALCIUM BISULFITE	—	—	—	—	X	X	BNTV	HYDROCYANIC ACID	X	—	—	—	X	X	ENTV
CALCIUM CHLORIDE	—	—	—	—	—	X	BENTV	HYDROGEN CHLORIDE GAS – DRY	—	—	—	—	—	X	ENTV
CALCIUM HYDROXIDE	—	X	X	X	X	X	BENTV	HYDROGEN GAS	X	X	X	X	X	X	BENTV
CALCIUM HYPOCHLORITE	—	—	—	—	—	X	ETV	HYDROGEN PEROXIDE	—	—	—	—	X	X	ETV
CALCIUM NITRATE, 40%	X	—	—	X	X	X	B	HYDROGEN SULFIDE	—	—	—	—	X	X	ET
CARBOLIC ACID (PHENOL)	—	—	—	—	X	—	TV	"HYPO"	—	—	—	—	X	—	B
CARBON DIOXIDE – DRY	X	X	X	X	X	—	BENT	HYPOCHLOROUS ACID, 20%	—	—	—	—	—	X	ETV
CARBON DISULFIDE	X	X	X	X	X	—	TV	ISOBUTYL ACETATE	X	X	X	X	X	X	ET
CARBON TETRACHLORIDE	—	—	—	X	X	—	TV	ISOPROPYL ACETATE	—	—	—	X	X	—	ET
CARBONATED BEVERAGES	X	—	—	—	X	X	N	JET FUEL	X	X	X	X	X	—	TV
CARBONIC ACID	X	—	—	—	X	X	BENTV	KEROSENE	X	X	X	X	X	—	BNTV
CASTOR OIL	—	—	—	—	X	X	BENTV	KRAFT LIQUOR (PAPER INDUSTRY)	—	—	—	—	—	X	T
CAUSTIC POTASH	—	—	—	X	—	X	BENTV	LACQUERS	X	X	X	—	X	—	BT
CAUSTIC SODA	—	—	—	X	—	X	BENT	LACTIC ACID, 20%	—	—	—	—	X	X	ENTV
"CELLOSOLVES"	X	X	X	X	X	—	ET	LACTIC ACID, 70%	—	—	—	—	X	X	ENTV
– METHYL	—	X	X	X	X	—	B	LARD	—	—	—	—	X	X	N
CHLORINE – DRY	—	—	—	—	—	—	NV	LEAD: CHLORIDE SULFATE	—	—	—	—	—	X	BNTV
CHLOROBROMOMETHANE	—	X	X	—	X	—	V	LIME SLURRY	—	—	—	—	X	X	B
CHLOROFORM – DRY	X	X	X	—	X	—	NTV	LIME SULPHUR	—	—	—	X	X	X	BENTV
"CHLOREX"	—	X	X	—	—	—	N	LINOLEIC ACID	—	—	—	—	X	X	BSTV
CHROMIC ACID – 50%	—	—	—	X	X	X	BNTV	LINSEED OIL	—	—	—	—	X	X	BNTV
CITRIC ACID	—	—	—	—	X	X	BENT	L.P.G.	X	X	X	X	X	—	B
COBALTZED SUPER COMPOUND	—	—	—	—	—	X	B	COBALTZED SUPER COMPOUND	—	X	X	X	X	X	BENTV



With many companies operating with lower inventories these days, the large inventories at APG are more important than ever to our customers. As always, we plan to have what you need in stock with same or next day shipping – exactly what you expect from “America’s Most Responsive Warehouse.”

Material Recommendations (Continued)

Fluid	Aluminum	Cast Brass	Forged Brass	Ductile Iron	Stainless Steel	Polypropylene	Gasket	Fluid	Aluminum	Cast Brass	Forged Brass	Ductile Iron	Stainless Steel	Polypropylene	Gasket
MAGNESIUM CHLORIDE	—	—	—	—	X	X	B E N T V	SILICONE OIL	—	—	—	—	X	X	B E N T V
MAGNESIUM HYDROXIDE	—	X	X	X	X	X	B E N T V	SILVER NITRATE	—	—	—	—	—	X	B E N T V
MAGNESIUM NITRATE	X	—	—	—	X	X	B E N T V	SOAP SOLUTIONS	—	—	—	—	X	X	B E N T V
MAGNESIUM SULFATE	X	—	—	—	X	X	B E N T V	SODA ASH	—	—	—	X	X	X	B E N T V
MERCURIC CHLORIDE	—	—	—	—	—	X	B E T V	SODIUM BICARBONATE	—	X	X	—	X	X	B E N T V
MERCURY	—	—	—	X	—	X	B E N T V	SODIUM BISULFATE	—	—	—	—	X	X	B E N T V
METHANE	X	X	X	X	X	—	B E N T V	SODIUM BORATE	X	X	X	—	X	X	B E N T V
METHANOL	X	X	X	X	X	X	B E N T	SODIUM PERBORATE	—	—	—	—	X	X	B E N T V
METHYL AMYL ACETATE	—	—	—	—	—	X	E	SODIUM CARBONATE	—	—	—	X	X	X	B E N T V
METHYLENE CHLORIDE	—	—	—	—	X	—	T V	SODIUM CHLORIDE	—	X	X	X	X	X	B E N T V
METHYL BENZENE	X	X	X	X	X	—	V	SODIUM CYANIDE, 10%	—	—	—	X	X	X	B E N T V
METHYL ETHYL KETONE	X	X	X	X	X	X	E N T	SODIUM DICHROMATE, 10%	—	—	—	—	—	X	E T
MILK	X	—	—	—	X	X	B E N T V	SODIUM HYDROXIDE, 40%	—	—	—	X	X	X	B E N T
MINERAL OIL	X	X	X	X	X	X	B N T V	SODIUM HYPOCHLORITE, 20%	—	—	—	—	—	X	E T V
MOLASSES	X	X	X	X	X	X	N	SODIUM METAPHOSPHATE	—	X	X	—	X	X	B E N T V
MURIATE OF POTASH	—	—	—	X	—	X	B E N T V	SODIUM NITRATE	X	—	—	X	X	X	B E N T
MURIATIC ACID	—	—	—	—	—	X	T V	SODIUM PEROXIDE	—	—	—	X	X	X	B E N T V
NAPHTHA	X	X	X	—	X	—	B T V	SODIUM PHOSPHATE – MO-NO-BASIC	—	X	X	X	X	X	B
NAPHTHALENE	X	X	X	X	X	—	T V	SODIUM PHOSPHATE – DI-BASIC	—	X	X	X	X	X	B
NAPHTHENIC ACID	—	X	X	X	X	—	B	SODIUM PHOSPHATE – TRI-BASIC	—	X	X	X	X	X	B
NATURAL GAS	X	X	X	X	X	X	B	SODIUM SILICATE	—	X	X	X	X	X	B E N T V
NICKEL CHLORIDE	—	—	—	—	X	X	B E N T V	SODIUM SULFATE	—	X	X	—	X	X	B E N T V
NICKEL SULFATE	—	—	—	—	X	X	B E N T V	SODIUM SULFIDE	—	—	—	—	X	X	B E N T V
NITRIC ACID	—	—	—	—	X	X	T V	SODIUM THIOSULFATE	—	—	—	—	X	X	B E N T V
NITROBENZENE	X	—	—	X	X	—	E T V	SOYBEAN OIL	—	—	—	—	X	X	B N
NITRO LIME	—	—	—	—	—	X	B	STANNIC CHLORIDE	—	—	—	—	—	X	B E N T V
OCTANE	X	X	X	X	X	—	V	STANNOUS CHLORIDE, 15%	—	—	—	—	X	X	B E N T V
OIL – CORE	—	X	X	X	X	—	B	STEAM	—	—	—	—	X	—	V
OIL – FUEL	X	X	X	X	X	—	B N T V	STEARIC ACID	—	—	—	—	X	X	B N T V
OIL – HYDRAULIC	X	X	X	X	X	X	B	STODDARD SOLVENT	X	X	X	X	X	—	B T V
OIL – CRUDE	—	—	—	—	X	—	B	STYRENE	X	—	—	—	X	—	V
OIL – REFINED	X	X	X	X	X	—	B	SUGAR LIQUORS – CANE	X	X	X	X	X	X	B E N T V
OIL – TRANSMISSION	—	X	X	X	X	X	V	SUGAR LIQUORS – BEET	X	—	—	X	X	X	B E N T V
OIL – VEGETABLE	—	—	—	—	X	X	B N T V	SULFATE LIQUORS	—	—	—	—	X	X	B N T V
OLEIC ACID	—	—	—	X	X	X	B T	SULPHITE LIQUORS	—	—	—	—	X	X	B N T V
OLEUM	—	—	—	X	X	—	T V	SULFURIC ACID	—	—	—	—	—	X	T V
OXALIC ACID	X	—	—	—	—	X	B E T V	SULFUROUS ACID	—	—	—	—	X	X	T V
OXYGEN	X	X	X	X	X	X	B E N T V	SUPER-PHOSPHATE	—	—	—	—	—	X	B
PALMITIC ACID	—	—	—	—	X	X	B T V	TANNIC ACID, 10%	—	—	—	—	X	X	B E N T V
PARAFFIN	X	X	X	X	X	X	B N T V	TAR – WOOD	X	X	X	X	X	X	B
PENTACHLOROPHENOL – DRY	—	—	—	—	—	—	T	TARTARIC ACID	—	—	—	—	X	X	B N T V
PERCHLOROETHYLENE	—	—	—	X	X	—	T V	TITANIUM TETRA CHLORIDE – DRY	—	—	—	—	X	X	T V
PHOSPHORIC ACID	—	—	—	—	X	X	E N T V	TOLUENE/TOLUOL	X	X	X	X	X	—	B T V
PHOTOGRAPHIC SOLUTIONS	—	—	—	—	—	X	B N T V	TETRACHLOROETHYLENE	—	—	—	—	X	—	V
PHTHALIC ANHYDRIDE	X	X	X	X	X	X	E N T V	TRICHLOROETHYLENE – DRY	—	X	X	X	X	—	T V
PICRIC ACID – MOLTEN	—	—	—	—	X	—	V	TRIETHANOLAMINE	X	—	—	X	X	X	B E N T V
– AQUEOUS SOLUTION	—	—	—	—	X	X	V	TRISODIUM PHOSPHATE	—	—	—	—	X	X	B N T V
PLATING SOLUTIONS, CHROME	—	—	—	—	—	X	E N T V	UREA	X	—	—	—	X	X	B E N T V
POTASSIUM ACETATE	—	X	X	X	X	X	B E T V	URINE	—	—	—	—	—	X	B E N T V
POTASSIUM CHLORIDE	—	—	—	—	—	X	B E N T V	VARNISH	X	—	—	—	X	—	B V
POTASSIUM CYANIDE	—	—	—	—	X	X	B E N T V	VINEGAR	X	—	—	—	X	X	E N T V
POTASSIUM DICHROMATE	X	X	X	X	X	X	B E T V	WATER – ACID MINE	—	—	—	—	X	X	B E N T V
POTASSIUM HYDROXIDE, 30%	—	—	—	—	X	X	B E N T	WATER – DEIONIZED	—	—	—	—	—	X	N
POTASSIUM NITRATE	X	X	X	X	X	X	B E N T V	WATER – DEMINERALIZED	—	—	—	—	—	X	N
POTASSIUM SULFATE	X	X	X	—	X	X	B E N T V	WATER – DISTILLED	X	—	—	—	X	X	B E N T V
PROPANE	X	X	X	X	X	—	B T V	WATER – FRESH	X	X	X	—	X	X	B
PROPYLENE GLYCOL	X	X	X	X	—	X	B N T V	WATER – SALT	—	X	X	—	X	X	B E N T V
PROPYLENE OXIDE	—	—	—	—	X	—	E T	WHITE LIQUOR (PAPER INDUSTRY)	—	—	—	—	X	X	B E N T V
ROSIN	X	—	—	—	X	X	B	WINE	—	—	—	—	X	X	B E N T V
SALT WATER	—	X	X	—	X	X	B	XYLENE/XYLOR	X	X	X	—	X	—	T V
SHELLAC	X	—	—	—	X	X	B	ZINC CHLORIDE	—	—	—	—	—	X	B E N T V
SILICONE FLUID	—	—	—	—	X	—	B E	ZINC NITRATE SULPHATE	X	—	—	—	X	X	B E N T V

Polypropylene not recommended for food service.

LEGEND: X = Recommended; B = Buna; E = EPT/EPDM; N = Neoprene; S = Silicone; T = PTFE; V = Fluoroelastomer

Notes: (1) All recommendations for pure chemicals at normal temperature unless otherwise stated.

(2) Temperature, concentrations, impurities, and other chemicals present can affect chemical resistance. It is not possible to test in all chemicals and therefore some chemical resistance indicators are based on the manufacturer's best estimates known about various classes and the composition of various metallurgies and elastomers. Therefore, manufacturers do not certify results from a performance standpoint but state they should be used only as indicators of chemical resistance. APG assumes no responsibility whatsoever.

(3) The information contained in these tables was derived from several sources and is to be used as a general guide only. Metallurgies and elastomers suitable for any specific application rests solely by the end user. APG assumes no responsibility whatsoever.



The APG Product Line

Industrial Hose Couplings

Accessories
 Cam & Groove Gaskets
 Fuel Gaskets
 Hammer Union Seals
 Handle, Ring, Pin
 Pipe Coupling Gaskets
 Safety Cables
 Sanitary Gaskets
 Air Hose - Coupled
 Cam and Groove
 EVER-TITE®
 Tough-TITE®
 U-TITE®
 90
 Heavy Duty Ductile Iron
 Increasers / Reducers
 Spool Couplers & Adapters
 Swivel
 Clamps
 Band-IT
 Ideal
 APG Worm Gear
 Band-IT Tools
 Combination Nipples/ Menders
 Crimp Sleeves & Ferrules
 Fire Fittings
 NH Thread Couplings
 Hydrant Adapters
 Hex Nipples
 Ground Joint
 Hose Barb Fittings
 Hose Shank
 Hydraulic Hose
 Pin Lugs / Suction Couplings
 Protective Sleeving - Bentley - Harris
 Quick Disconnect
 Railroad Tank Car Adapters
 Sandblast
 Strainers
 Transportation
 Drop Couplers
 Dust Plug w/ Pull Handle & Bump
 Elbow
 Couplers & Adapters with Relief Nipple
 Tight Fill
 Vapor Recovery
 Flange Couplings and Gaskets
 Universal / Crowfoot
 Valves
 Check
 Foot
 Gate

Pressure Gauges

Dry - Black Steel w/Brass
 Connections
 Liquid Filled
 Stainless Steel Case w/ Brass
 Connections
 All Stainless Steel

O-Rings

Aflas® 80 Durometer
 Chloroprene 70 Durometer
 E.P.R. 70 Durometer
 Standard & Metric
 E.P.R. Peroxide Cured
 80 Durometer
 Fluoroelastomer - Black
 Standard 75 & 90 Durometer
 Metric 75 & 90 Durometer
 Fluoroelastomer - Brown
 Standard 75 & 90 Durometer
 Metric 75 Durometer
 Fluorosilicone 70 Durometer
 Highly Saturated Nitrile
 Green 70 Durometer
 Standard & Metric
 Black 80 & 90 Durometer
 Blue TFE Coated 70 Durometer
 Kalrez® 4079
 Nitrile - Black
 Standard 50, 70, 90 Durometer
 Metric 70 & 90
 Large Cross Section 70 Durometer
 Nitrile - Black - Peroxide Cured
 90 Durometer
 PTFE
 Silicone 70 Durometer
 Standard & Metric
 Square Cut Rings
 Nitrile 70 Durometer
 Teflon® Encapsulated
 Viton® Core
 Silicone Core
 Urethane 70 & 90 Durometer
 4 Lobe Q-Rings
 Nitrile 70 Durometer
 Fluoroelastomer 75 Durometer
 Minesota Quad-Rings®
 Available at APG Ohio
 366Y Nitrile 70 Durometer
 514AD FKM 70 Durometer
 Non-Standard Sizes
 Vulcanized
 Kits
 Standard
 Metric
 Splicing
 Specialty
 O-Ring Accessories
 Measuring Devices
 Cones
 Tapes
 Sizing
 Gauges
 Compound Identifiers
 Lubricants
 Picks

FDA O-Rings

E.P.R. Peroxide Cured NSF FDA
 White 70 Durometer
 Fluoroelastomer FDA - White 60 Durometer
 Nitrile FDA- Black 70 Durometer
 Nitrile FDA- White 70 Durometer
 Nitrile Metal Detectable 70 Durometer
 Silicone FDA - 70 Durometer

Back-Up Rings

PTFE
 Solid
 Split
 Spiral
 Contoured Back-Up Rings
 Nitrile 90 Durometer
 Fluoroelastomer 90
 Durometer
 Leather

O-Ring Cord

Aflas® 75 Durometer
 E.P.R. 70 Durometer
 Fluoroelastomer - standard & metric
 Inch 75 & 90 Durometer
 Metric 75 Durometer
 Square 75 Durometer
 Fluoroelastomer - Brown
 75 Durometer
 Neoprene 70 Durometer
 Neoprene Sponge - Closed Cell
 Nitrile
 Inch - 50, 70, & 90 Durometer
 Metric - 70 & 90 Durometer
 Square - 70 Durometer
 Silicone 70 Durometer
 Inch 70 Durometer
 Metric 70 Durometer
 4-Lobe Q-Ring
 Nitrile 70 Durometer
 Fluoroelastomer 75

Extrusions

EPDM
 Fluoroelastomer
 Neoprene - White
 Neoprene Sponge - Closed Cell
 Silicone - Gray

Hydraulic Seals

Loaded Lip Seals
 Metal Clad Wipers
 Metric Bonded Seals
 Metric Compact Piston Seals
 Metric Oil Seals
 Metric U-Cups
 Metric V Seals
 Metric Wipers
 Piston Cups
 Rod Wipers
 T-Seals
 U-Cups
 Vee Packings
 Wear Rings
 Wear Strips
 WV Rings



APG universal crowfoot couplings (or "Chicago" fittings as they are commonly called) have easily established a reputation of superiority in the marketplace. They are low carbon steel as opposed to ductile iron – allowing a machined finish beneath the grommet which provides a better seal. And this added benefit even comes with a less expensive price tag!

The APG Product Line (Continued)

Custom Molded Rubber

Mandrel Built & Lathe Cut Products
 Rubber Roll Coverings
 Rubber / Fabric Products
 Rubber to Metal Bonding

Sheet Material

Black Rubber Sponge
 Open Cell
 Black Rubber - Cloth Inserted
 Butyl
 Chipboard
 Compressed Non-Asbestos
 Cork
 Cork and Buna-N
 Cork and Neoprene
 Cork and Neoprene Spiral
 Ribbon
 Cork and Synthetic Rubber
 Adhesive Backed
 EPDM
 Felt – Gray, White, & Green
 Fibre-Cork
 Fiberglass Cloth
 Fiberglass Wire Inserted
 Tacky Cloth
 Filled PTFE
 Fish Paper
 Flexible Graphite
 Fluoroelastomer
 Fluoroelastomer - Nylon Inserted
 Gum Rubber
 Hypalon
 Leather
 Koroseal®
 Neoprene 40, 60, 70, &
 72 Durometer
 Neoprene Cotton and
 Nylon Inserted
 Nitrile 50, 60, & 90 Durometer
 Nitrile - White 50-65 Durometer
 Nitrile Sponge - Closed Cell
 Nitrile Nylon Inserted
 Nitrile - Transformer Grade
 Nomex® Paper
 Nylon
 PCTFE
 Plant (Vegetable) Fiber
 Red Rubber
 Silicone 50 and 70 Durometer
 Silicone Sponge
 Tank Gasket
 TFE and TFE Glass Filled
 Vinyl Matting
 Vulcanized Fiber
 Bone Hard - Red

Fabrication

Gaskets
 Water-jet Cut
 Steel Rule Die Cut
 Industrial Glass

Fabrication (Continued)

Pipeline Scraper Discs
 Stripping (with optional adhesive backing)
 Tank Strips & Gaskets
 Vulcanizing
 Non-Standard O-Rings
 Sleeves
 Gaskets

Spiral Wound Gaskets

304 Stainless Steel / Graphite
 316 Stainless Steel / Graphite

Packing

Aramid Filament
 Carbon / Graphite
 Carbon / TFE
 Flax and Flax / TFE
 General Service Packing
 G.F.O.®
 Graphite Filament
 Inconel Wire-Inserted
 Novoloid Fiber / PTFE
 Pre-Lubed TFE Yarn
 Pre-Lubed TFE Yarn (FDA)
 PTFE Cord Packing
 Stuffing Box Packing (S.B.S.)
 TFE Yarn
 Twisted Fiberglass Rope & Wick

Industrial Glass

Tubular Gauge Glass
 Standard
 High Pressure
 Red Line
 Heavy Wall
 Heavy Wall Red Line
 Borosilicate Flat Glass
 Circles
 Rectangles
 Squares
 Flat Gauge Glass
 Plain
 High Pressure
 Reflex
 Vycor® Brand Flat Glass
 Circles
 Rectangles
 Squares
 Pyrex® Brand Annular Edge
 Sight Glass
 Annealed
 Tempered
 Fused Quartz
 Circles
 Rectangles
 Squares
 Glass Accessories
 Guard Rods – Brass
 Water Gauges – Brass
 Gauge Glass Cutters

Industrial Glass (Continued)

Glass Accessories (continued)
 Gauge Glass Gaskets
 PCTFE Shields
 Mica Shields

Plastic Product , Die Cut

Replacement Safety Visors
 Safety Visor Headgear
 Safety Visor Hardhat Adapters
 Replacement Lenses for
 Sandblasting Helmets
 Plastics for the Printing Industry
 Custom Fabricated Die-Cut
 Plastic Products

Plastic Product , Machined

Custom Designs
 Back-Up Rings
 Guide Rings
 Rod Seals
 Piston Rings
 Wipers

Specialty & Miscellaneous

Fastener Seals
 Thread Seals
 Mechanical Seal Components
 O-Ring Groove Seats
 Ceramic
 Tungsten-Carbide
 Silicon-Carbide

Tools

Gasket Cutters
 Gasket Knives
 Gauge Glass Cutters
 Packing Hooks
 O-Ring Picks
 Punches & Punch Sets
 Clamping System Tools

Tapes

Fiberglass
 Kapton®
 Polyester
 Silicone Adhesive Backed
 Solid
 Silicone Adhesive Backed
 Sponge
 Teflon® Fiberglass
 TFE Pipe Thread Tape

Adhesives

PTFE Flange Sealant
 Stop-It® Pipe Repair System

24/7 Call Out Service



CALL US



EMAIL



FAX



WALK-IN

"AMERICA'S MOST RESPONSIVE WAREHOUSE"



FAQs

Frequently asked Questions

What can APG do to help me sell their products?

APG offers on-site training for any product APG has to offer to inform of features and applications. Also available are joint sales calls with one of APG's knowledgeable Regional Sales Managers or Product Managers.

Can APG help me outside of normal business hours?

Yes. APG has a 24/7 call out service because emergencies don't only occur Monday through Friday from 8-5. Someone will be readily available to take your order and get it out so that production can continue.

Can I customize my products?

Yes. APG offers customization across all product lines. Vulcanizing, Gasket and Industrial Glass Fabrication, O-ring Bagging and Labeling, Metal Weld Fabrication, Machined and Die-Cut Plastics. See front of this catalog for more details.

What materials do you offer for the Crowfoot Coupling replacement gaskets?

Currently, APG stocks Nitrile Crowfoot Coupling replacement gaskets.



"America's Most Responsive Warehouse"



FAQs

Frequently asked Questions

What is the freight allowance policy?

Orders totaling \$1500 or more at NET prices, any product mix, receive full freight prepaid and allowed, provided such orders are for one shipment within the lower 48 continental United States and provided our normal freight modes are used. Exceptions to this freight policy: all glass products. These products are FOB our warehouse with no freight allowance unless other items on the order total \$1500 or more at NET prices.

What can be transferred within the EVER-TITE®, Tough-TITE®, or U-TITE® products?

These Cam & Groove couplings are designed ONLY for low pressure liquid transfer.

What information does APG need to assist me in identifying the Gasket or O-ring I need?

To assist in identifying your product APG will require material, durometer, thickness, standard size or inside and outside diameter, and, if applicable, bolt-hole diameter.

What other products does APG carry?

The APG product line includes Stop-IT Pipe Repair System, Teflon Tape, Packing, Weather Stripping, Gaskets, Sheet Material and Full Rolls, Spiral Wound and Electrical Conduit Gaskets, Standard & Metric O-Rings, Kits, O-ring Cord, Hydraulic Seals, Pressure Gauges, Industrial Hose Couplings, Industrial Glass, Machined Plastics, Safety Plastics, Die-Cut Plastics, Adhesives and Sealants.

Don't forget to sign-up for our monthly newsletter @ www.CALLAPG.com and stay informed!



“America’s Most Responsive Warehouse”

APG - Houston

6039 Armour Drive
Houston, TX 77020
(713) 675-5271
1-800-888-5223

APG - Ohio

1004 Commerce Drive
Grafton, OH 44044
440-926-1234 Phone
800-883-7457 Toll Free

APG - Knoxville

5324 S. National Drive
Knoxville, TN 37914
865-540-8199 Phone
800-382-8483 Toll Free

West Coast Warehouse

13724 Borate Street
Santa Fe Springs, CA 90670
800-500-4222 Toll Free



Packing and Gaskets • Sheet Material and Full Rolls • Gasket Fabrication • Stripping and Adhesive Backing Spiral Wound Gaskets • Mechanical Seal Components • Standard O-Rings • Metric O-Rings • O-Ring Kits • O-Ring Cord • Vulcanizing • Custom Rubber Fabrication • Hydraulic Seals • Pressure Gauges • EVER-TITE® • Industrial Hose Couplings • Industrial Glass • Glass Fabrication • Machined Plastics • Safety Plastics • Die-Cut Plastics • Adhesive and Sealant

