

2017

KOMELON®

USA Division

PRODUCT CATALOG

VOL.14



METER-MAN®
by KOMELON®

KOMELON Corporation

The world's most vertically integrated measuring tape manufacturer. From our raw material manufacturing plant to global marketing and distribution, KOMELON handles it all with the most advanced and innovative R & D technology. This assures our customers the highest quality products available.

For over 50 years, Komelon has manufactured a full line of quality measuring tools with dedication and a passion for craftsmanship while supplying markets throughout the world.

Komelon Corporation - Korea, Since 1963

This is the corporate headquarters housing all product design, engineering and research & development. This facility also manufactures the Meter-Man Measuring wheel line.

Komelon Steel Corporation - Korea, Since 1995

Komelon manufactures its own steel strip material for all blades and springs used in tape measure production. This ensures the highest quality tape measures on the market.

Komelon China, Since 2002

This state-of-the-art measuring tool manufacturing facility, located in Qingdao, China was recently built to better serve Komelon's rapidly growing worldwide sales.

Komelon SAW - Korea, Since 2012

Komelon Saw manufacturing facility located at our corporate facility in S.Korea is an industry leading manufacturer of high end pruning saws.

Komelon USA Division, Since 1997

This sales and distribution center for North America warehouses high inventory levels to ensure fast shipments and superior customer service.



KOMELON Corporation



KOMELON Steel



KOMELON China



KOMELON SAW - Korea



KOMELON USA Division

CONTENTS

PowerBlade Tapes

See Page 4~8

- PowerBlade™II, Magnetic PowerBlade™II
- ABS PowerBlade™II, Magnetic ABS PowerBlade™II
- Stainless Steel ABS PowerBlade™II
- Self Lock ABS PowerBlade™II

Stainless Steel Tapes

See Page 9~11

- Stainless Steel Gripper™
- Stainless Steel Self Lock™

Self Lock Tapes

See Page 12~14

- Self Lock™ Evolution
- Self Lock™, Chrome Self Lock™, Speed Mark Self Lock™

Magnetic Tapes

See Page 15~17

- Monster MagGrip™
- MagGrip™, Neo MagGrip™

Power Tapes

See Page 18~28

- Big John™, Mighty Mite™
- The Chrome Professional™, The Professional™
- Gripper™X, Gripper™Speed Mark™, Gripper™
- Power Tape™, The Tradesmen™
- Colours™, Touch Lock™

Fiberglass Tapes

See Page 29~31

- Fast Back™, Fiber Reel(open)

Long Steel Tapes

See Page 32~36

- Metal Frame Steel Reel, Steel Reel
- Gripper™
- Long Steel Information

Accessories

See Page 37~38

- Flat Tape
- Torch Safe
- Keychain Tapes

Private Label Program

See Page 39

Measuring Wheel

See Page 40~47

Komelon Saw

See Page 48~54



POWERBLADE TAPES

POWERBLADE™ III

The Powerblade II features the Komelon high visibility blade. The High Visibility paint color makes this tape very easy to read in all types of light. It also features larger printing on the blade. This Powerblade has been redesigned to be more compact and easier to handle. The Powerblade II magnetic also features our patented magnetic end hook for easier one person measuring (72425).



81416, 81425, 81430

72425

- Ultra-compact case
- New high visibility blade color & Large read numbers
- Wider blade for added stand out
- Printing on both sides of blade with dual end hook
- Magnetic dual end hook allows for easier one person measurement (72425)

Horizontal Graduations On Front



Vertical Graduations On Back



POWERBLADE™ III

ITEM NO.				QTY.	LBS.	CU FT.	
81416	16 ft.	1 1/16 in.	6	24	22.9	0.88	6 50056 81416 0
81425	25 ft.	1 1/16 in.	6	24	30.3	0.88	6 50056 81425 2
81430	30 ft.	1 1/16 in.	6	24	35.2	0.95	6 50056 81430 6

MAGNETIC TIP

POWERBLADE™ III

ITEM NO.				QTY.	LBS.	CU FT.	
72425	25 ft.	1 1/16 in.	6	24	30.4	0.89	6 50056 72425 4

ABS POWERBLADE™

Introducing our newest ABS Power Blade that features a reinforced ABS plastic housing and High Visibility blade. The High Visibility paint color makes this tape very easy to read in all types of light. It also features larger printing. This Power Blade has been redesigned to be more compact and easier to handle. The new & re-designed Power Blade also has an option with our patented magnetic end hook.



- Ultra-compact case
- New high visibility blade color & Large read numbers
- Wider blade for added stand out
- Printing on both sides of blade with dual end hook
- Magnetic dual end hook allows for easier one person measurement (73425)





Horizontal Graduations On Front







Vertical Graduations On Back



ABS POWERBLADE™

ITEM NO.				QTY.	LBS.	CU FT.	
52416	16 ft.	1 1/16 in.	4	24	22.9	0.99	6 50056 52416 8
52425	25 ft.	1 1/16 in.	4	24	30.3	0.99	6 50056 52425 0
52430	30 ft.	1 1/16 in.	4	24	30.3	1.05	6 50056 52430 4
52435	35 ft.	1 1/16 in.	4	24	35.2	1.12	6 50056 52435 9

MAGNETIC TIP ABS POWERBLADE™

ITEM NO.				QTY.	LBS.	CU FT.	
73425	25 ft.	1 1/16 in.	4	24	30.4	0.99	6 50056 73425 3

STAINLESS STEEL

ABS POWERBLADE™ III

The Stainless Steel ABS Powerblade is the newest member to the Powerblade family. This tape measure provides the durable stainless steel spring, endhook, belt clip and fasteners. This helps prevent rusting and extends the life of the tape measure, resulting in the most durable tape measure on the market. The SS Powerblade offers a wider blade for added stand out and easier one person measuring. This tape measure is ideal for anyone working in damp or wet environments.



SS52416, SS52425

- Ultra-compact case
- Wider blade for added stand out
- Printing on both sides of blade with dual end hook
- Non glare silver blade
- Built in stainless steel spring

Horizontal Graduations On Front



Vertical Graduations On Back



Stainless Steel Blade

STAINLESS STEEL

ABS POWERBLADE™ III

ITEM NO.				QTY.	LBS.	CU FT.	
SS52416	16 ft.	1 1/16 in.	4	24	30.4	0.99	6 50056 56416 4
SS52425	25 ft.	1 1/16 in.	4	24	30.4	0.99	6 50056 56425 6

SELF LOCK

ABS POWERBLADE™ II

Another new member to the Powerblade II family is our NEW Self Lock ABS Powerblade. Upon popular demand we've created the most feature packed tape measure to date. This tape offers our patented self locking mechanism, wide blade, high visibility blade color and back side blade printing. This tape measure is designed to handle all your measuring needs.

NEW
Design



- Automatic blade lock
- Easy to work push button retrieval
- Ultra-compact case
- Wider blade for added standout
- Printing on both sides of blade with dual end hook

Horizontal Graduations On Front



Vertical Graduations On Back



Self Locking

SELF LOCK

ABS POWERBLADE™ II

ITEM NO.				QTY.	LBS.	CU FT.	
SL52425	25 ft.	1 1/16 in.	4	24	-	-	6 50056 54425 8



STAINLESS STEEL *TAPES*

STAINLESS STEEL™

All metallic components are Stainless Steel to resist rusting and extend the life of the tape measure. These tapes are ideal for working in wet or dirty conditions and have a non glare silver blade.



SS116, SS125, SS130

- Durable rubberized case for easy grip
- Slide lock holds blade firmly
- Non glare silver blade
- Built in stainless steel spring
- Stainless steel blade and end hook





Horizontal Graduations On Front



Vertical Graduations On Back



Stainless Steel Blade

ITEM NO.				QTY.	LBS.	CU FT.	
SS116	16 ft.	1 in.	4	24	18.5	0.77	6 50056 03416 2
SS125	25 ft.	1 in.	4	24	28.0	0.80	6 50056 03425 4
SS130	30 ft.	1 in.	4	24	30.3	0.87	6 50056 03430 8

SELF LOCK™ STAINLESS STEEL™

The Stainless Steel Self Lock combines two great features into one unique tape measure. Not only does this tape have the self locking feature of our #1 selling tape, it is also made with stainless steel components to help prevent rusting and extend the life of the tape.



SLSS125

- Durable chrome case with protective rubber
- Easy to work thumb push button retrieval
- Automatic blade lock
- Non glare silver blade
- Built in stainless steel spring
- Stainless steel blade and end hook



Stainless Steel Blade

Horizontal Graduations On Front



ITEM NO.				QTY.	LBS.	CU FT.	
SLSS125	25 ft.	1 in.	4	24	27.0	0.79	6 50056 10125 3

SELFLOCK TAPES



SELF LOCK™ EVOLUTION

Komelon took our best selling tape series to a whole new level. The Evolution is loaded with features. This tape measure is equipped with our new High Visibility blade, a dual end hook, and back side printing on the blade.



EV28116, EV2825, EV2830

- Automatic blade lock
- Easy to work thumb push button retrieval
- Nylon coated blade for maximum durability
- Ergonomically designed case
- High Visibility blade color
- Dual end hook
- Printed on both sides of blade

Horizontal Graduations On Front



Vertical Graduations On Back



Self Locking

ITEM NO.				QTY.	LBS.	CU FT.	
EV28116	16 ft.	1 in.	4	24	19.6	0.80	6 50056 03816 0
EV2825	25 ft.	1 in.	4	24	27.1	0.89	6 50056 03825 2
EV2830	30 ft.	1 in.	4	24	30.7	0.89	6 50056 03830 6

SELFLOCK™ Line Up

- Easy to work thumb push button retrieval
- Automatic blade lock
- Nylon coated blade



SL2825

- Chrome case
- Easy to work thumb push button retrieval
- Automatic blade lock
- Large read printed scale is 30% larger than regular scale
- Non glare silver blade

Large Read Numbers



SL225

- Yellow ABS case with protective rubber
- Easy to work thumb push button retrieval
- Automatic blade lock
- Fractional graduations for easy read and accurate measurement

Fractional Graduations



SL2925

ITEM NO.				QTY.	LBS.	CU FT.	
SL2812	12 ft.	5/8 in.	4	24	11.0	0.66	6 50056 02812 3
SL2816	16 ft.	3/4 in.	4	24	15.0	0.70	6 50056 02816 1
SL28116	16 ft.	1 in.	4	24	18.5	0.79	6 50056 28161 0
SL2825	25 ft.	1 in.	4	24	26.0	0.79	6 50056 02825 3
SL2825IE	25 ft.	1 in.	4	24	26.0	0.79	6 50056 12825 0
SL2830	30 ft.	1 in.	4	24	29.6	0.99	6 50056 02830 7
SL225	25 ft.	1 in.	4	24	28.0	0.82	6 50056 00225 3
SL2912	12 ft.	5/8 in.	4	24	10.5	0.66	6 50056 02912 0
SL29116	16 ft.	1 in.	4	24	18.5	0.70	6 50056 29116 9
SL2925	25 ft.	1 in.	4	24	26.0	0.79	6 50056 02925 0



MAGNETIC TAPES

MONSTER MAGGRIP™

Komelon's unique patented magnetic end hook hold firmly on most metal surfaces and makes one person measuring easier.



7116, 7125, 7125IE, 7130

- Impact resistant rubberized case
- Nylon coated blade
- Magnetic dual end hook





Inch Blade

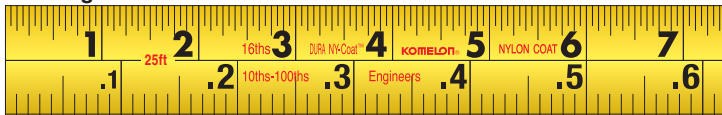

Inch/Engineer Blade



Magnetic Dual End Hook

ITEM NO.				QTY.	LBS.	CU FT.	
7116	16 ft.	1 in.	4	24	13.0	0.77	6 50056 07116 7
7125	25 ft.	1 in.	4	24	25.3	0.80	6 50056 07125 9
7125IE	25 ft.	1 in.	4	24	25.3	0.80	6 50056 71255 8
7130	30 ft.	1 in.	4	24	28.0	0.87	6 50056 07130 3

IE = Inch/Engineer Scale *IE is not printed on both sides

MAGGRIP™ / NEO MAGGRIP™



- Rubber jacket to protect case
- Compact case
- Nylon coated blade
- Magnetic end hook



7416, 7425, 7430, 7425IM

MagGrip™

Inch/Metric Blade



Large Read Numbers



ITEM NO.				QTY.	LBS.	CU FT.	
7416	16 ft.	1 in.	4	24	20.0	0.86	6 50056 07416 8
7425	25 ft.	1 in.	4	24	24.0	0.89	6 50056 07425 0
7425IM	25 ft. / 7.5 m	1 in.	4	24	24.0	0.89	6 50056 74250 0
7130	30 ft.	1 in.	4	24	29.0	0.99	6 50056 07430 4

IM = Inch/Metric Scale



- Compact case design
- High Visibility neon yellow color
- Acrylic coated blade
- Pause button on bottom to hold tape
- Magnetic end hook
- Fractional Graduations



7325, 7330

Neo MagGrip™

Fractional Graduations



ITEM NO.				QTY.	LBS.	CU FT.	
7325	25 ft.	1 in.	4	24	25.5	0.71	6 50056 07325 3
7330	30 ft.	1 in.	4	24	31.5	0.74	6 50056 07330 7



POWER TAPES

BIG JOHN & MIGHTY MITE



525C



535C

- Ultra compact 25' case (525C)
- Compact 35' chrome case fits comfortably in hand (535C)
- Positive lock holds blade securely
- Rich classic chrome look
- Nylon coated blade for maximum durability

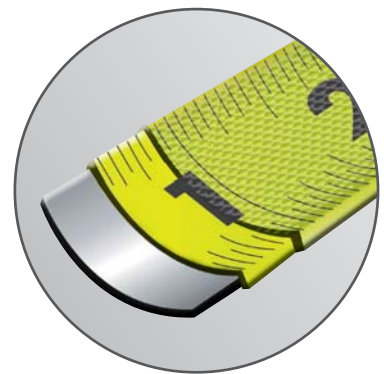

Nylon Coated Blade For Maximum Durability



ITEM NO.				QTY.	LBS.	CU FT.	
535C	35 ft.	1 in.	4	24	31.0	0.87	6 50056 20325 4
525C	25 ft.	1 in.	4	24	23.0	0.5	6 50056 20525 8

THE CHROME PROFESSIONAL™

Komelon has taken our popular chrome Professional series tapes and made them even better. We have added a High Visibility blade with large read printing to make this tape easier to read and mark with.



410HV, 412HV, 416HV, 425HV, 430HV
435HV, 425IEHV, 433IEHV

Large Read Numbers



Inch/Engineer Blade

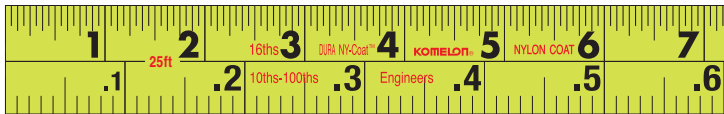

- Ergonomically designed chrome case
- Slide lock
- Nylon coated, High Visibility blade
- Available in feet/inches, inch/engineer
- Large read blade

ITEM NO.				QTY.	LBS.	CU FT.	
410HV	10 ft.	5/8 in.	4	24	8.2	0.61	6 50056 01410 2
412HV	12 ft.	5/8 in.	4	24	10.2	0.61	6 50056 01412 6
416HV	16 ft.	3/4 in.	4	24	14.3	0.67	6 50056 01416 4
425HV	25 ft.	1 in.	4	24	25.0	0.75	6 50056 01425 6
430HV	30 ft.	1 in.	4	24	28.0	0.90	6 50056 01430 0
435HV	35 ft.	1 in.	4	24	31.0	0.90	6 50056 01435 5
425IEHV	25 ft.	1 in.	4	24	25.0	0.75	6 50056 42501 4
433IEHV	33 ft.	1 in.	4	24	29.0	0.90	6 50056 43301 9

IE = Inch/Engineer Scale

GRIPPER™ SPEED MARK™



SM5412, SM5416, SM5425

- Easy grip, thick rubber jacket
- Positive lock holds blade firmly
- Speed mark fractional scale on blade



White
Speed Mark Blade

Fractional Graduations

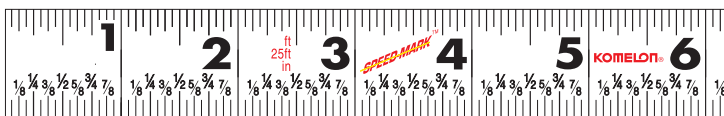

ITEM NO.				QTY.	LBS.	CU FT.	
SM5412	12 ft.	5/8 in.	4	24	11.0	0.55	6 50056 54121 9
SM5416	16 ft.	1 in.	4	24	18.5	0.76	6 50056 54161 5
SM5425	25 ft.	1 in.	4	24	26.0	0.76	6 50056 54251 3

SPEED MARK™



SM3912, SM3916, SM3925

- Ergonomic case design
- Durable ABS plastic case
- Acrylic coated blade
- Speed Mark fractional scale on blade

Fractional Graduations



Speed Mark Blade

ITEM NO.				QTY.	LBS.	CU FT.	
SM3912	12 ft.	5/8 in.	4	24	10.0	0.55	6 50056 39121 0
SM3916	16 ft.	3/4 in.	4	24	13.5	0.55	6 50056 39161 6
SM3925	25 ft.	1 in.	4	24	23.5	0.69	6 50056 39251 4

GRIPPER™ X



W4125IM



Compact Rubberized Case

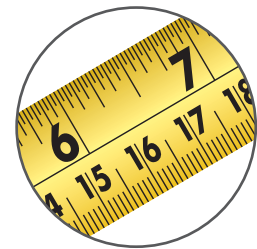

Inch/Metric Blade

- Compact rubberized ABS Case
- Positive lock holds blade firmly
- Inch/Metric blade

Inch/Metric Blade



ITEM NO.				QTY.	LBS.	CU FT.	
W4125IM	25 ft. / 7.5m	1 in.	2	12	13	0.40	6 50056 34125 3

THE PROFESSIONAL™



4912, 4916, 4925, 4930, 4933
4912IM, 4916IM, 4925IM, 4930IM





Inch Blade



Inch/Metric Blade



- Ergonomically designed ABS case
- Slide lock
- Nylon coated blade
- Available in feet/inches and inch/metric scales

ITEM NO.				QTY.	LBS.	CU FT.	
4912	12 ft.	5/8 in.	4	24	10.0	0.55	6 50056 04912 8
4916	16 ft.	3/4 in.	4	24	13.5	0.55	6 50056 04916 6
4925	25 ft.	1 in.	4	24	24.0	0.71	6 50056 04925 8
4930	30 ft.	1 in.	4	24	30.0	0.76	6 50056 04930 2
4933	33 ft.	1 in.	4	24	31.0	0.76	6 50056 04933 3
4912IM	12 ft. / 3.5m	5/8 in.	4	24	10.0	0.55	6 50056 49120 0
4916IM	16 ft. / 5m	3/4 in.	4	24	13.5	0.55	6 50056 49160 6
4925IM	25 ft. / 7.5m	1 in.	4	24	24.0	0.71	6 50056 49250 4
4930IM	30 ft. / 9m	1 in.	4	24	30.0	0.76	6 50056 49300 6

IM = Inch/Metric Scale

GRIPPER™



- Easy grip, thick rubber jacket
- Ergonomic, compact case design
- Acrylic coated blade

5925, 5930

5425, 5430, PG85

Inch Blade



Metric Blade



Thick Rubber Jacket

ITEM NO.				QTY.	LBS.	CU FT.	
5425	25 ft.	1 in.	4	24	24.0	0.74	6 50056 40525 2
5430	30 ft.	1 in.	4	24	28.0	0.80	6 50056 05430 6
5925	25 ft.	1 in.	4	24	24.0	0.74	6 50056 90525 7
5930	30 ft.	1 in.	4	24	28.0	0.80	6 50056 05930 1
PG85	8m	25mm	10	40	45.0	1.30	8 803005 26910 4

PG85 = Metric only

POWER TAPE™ / THE TRADESMEN™



- Thick, high carbon steel blade
- Triple riveted end hook

3725, 3925

Power Tape™

ITEM NO.				QTY.	LBS.	CU FT.	
3725	25 ft.	1 in.	4	24	22.5	0.70	6 50056 03725 5
3925	25 ft.	1 in.	4	24	22.5	0.70	6 50056 03925 9



T3725, T3925

The Tradesmen™

- High quality opening price point tape measure

ITEM NO.				QTY.	LBS.	CU FT.	
T3725	25 ft.	1 in.	12	48	45.0	1.15	6 50056 37252 3
T3925	25 ft.	1 in.	12	48	45.0	1.15	6 50056 39252 1

COLOURS™

POWER TAPES



3516

Fractional Graduations



Speed Mark Blade

- Assorted, eye catching transparent colors
- Compact case design
- Fractional graduations on blade

ITEM NO.				QTY.	LBS.	CU FT.	
3516	16 ft.	1 in.	4	24	17.0	0.65	6 50056 35162 7

TOUCH LOCK™



3110



Magnetic Back



- Small enough to fit in pocket or handbag
- Assorted, eye catching transparent colors
- Large center brake to hold blade at desired length
- Diameter scale on backside of blade
- Strong magnetic back secures tape to metal surface like refrigerators, tool boxes and filing cabinets

ITEM NO.				QTY.	LBS.	CU FT.	
3110	10 ft.	1/2 in.	6	36	11.3	0.49	6 50056 31100 3
3110D	10 ft.	1/2 in.	8	48	12.6	0.56	6 50056 31101 0

FIBERGLASS TAPES



FAST BACK™



- Heavy duty ABS frame
- Shock absorbing bumper
- 3 to 1 High speed rewind
- Double coated fiberglass blade
- Versatile end hook

8811



3X
3 TO 1
HIGH SPEED REWIND

Fiberglass Blade

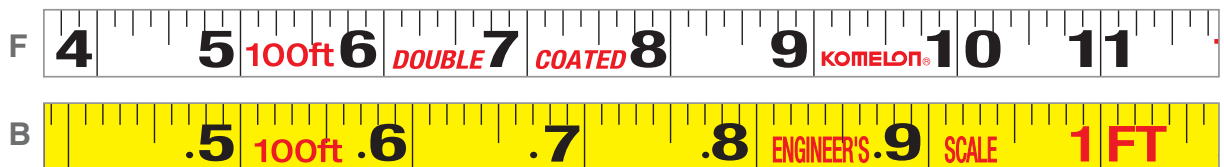

ITEM NO.				QTY.	LBS.	CU FT.	
8811	100 ft.	1/2 in.	-	5	7.0	0.60	6 50056 08811 0

FIBER REEL™



- Heavy duty ABS frame
- Shock absorbing bumper
- Double coated fiberglass blade
- Versatile end hook

6611, 6622, 6633, 6611IM, 6622IM, 66330IM, 6100E, 6200E



Ground Stake Included
Stake Locks into End Hook for Easier One Person Measuring

Inch Blade



Inch/Metric Blade



Engineer Blade



ITEM NO.				QTY.	LBS.	CU FT.	
6611	100 ft.	1/2 in.	-	5	8.8	0.98	6 50056 06611 8
6622	200 ft.	1/2 in.	-	5	12.1	1.30	6 50056 06622 4
6633	300 ft.	1/2 in.	1	5	19.9	1.44	6 50056 06633 0
6611IM	100ft./30m	1/2 in.	-	5	8.8	0.98	6 50056 66110 8
6622IM	200ft./60m	1/2 in.	-	5	12.1	1.30	6 50056 66220 4
66330IM	330ft./100m	1/2 in.	1	5	19.9	1.44	6 50056 66331 7
6100E	100 ft.	1/2 in.	1	5	10.2	0.58	6 50056 36100 8
6200E	200 ft.	1/2 in.	1	5	13.5	1.19	6 50056 36200 5

IM = Inch/Metric Scale E = Engineer only

LONGSTEEL *TAPES*







STEEL REEL™



- Wood handle
- Heavy duty metal frame
- Nylon coated blade
- Versatile end hook

N6300

Metal Frame Steel Reel

ITEM NO.				QTY.	LBS.	CU FT.	
N6300	300 ft.	1/2 in.	1	5	43.0	1.21	6 50056 16300 8







Komelon open reel steel features a nylon coated steel blade that will not stretch or distort. This high quality measuring tool is a must for anyone that needs to be extremely accurate.



- Heavy duty ABS frame
- Durable folding handle and rubber hand grip
- Nylon coated blade

N6100, N6200

Steel Reel

ITEM NO.				QTY.	LBS.	CU FT.	
N6100	100 ft.	1/2 in.	1	5	15.0	0.68	6 50056 16100 4
N6200	200 ft.	1/2 in.	1	5	22.0	0.81	6 50056 16200 1

IM = Inch/Metric Scale E = Engineer only

STEEL FAST BACK™ / GRIPPER™



- Compact, ergonomic case
- 3 to 1 High speed rewind
- Nylon coated blade
- Multifunction ring and claw end hook

9201

Steel Fast Reel™

ITEM NO.				QTY.	LBS.	CU FT.	
9201	100 ft.	3/8 in.	6	24	36.0	2.59	6 50056 09201 8

- Rubber jacketed case
- Nylon coated blade
- Available in feet/inches and inch/metric scales



9905, 9901, 9901IM

7100

Gripper™

ITEM NO.				QTY.	LBS.	CU FT.	
9905	50 ft.	3/8 in.	4	16	12.8	0.61	6 50056 09905 5
9901	100 ft.	3/8 in.	4	16	20.0	0.81	6 50056 09901 7
9901IM	100ft./30m	3/8 in.	4	16	20.0	0.81	6 50056 99010 9

IM = Inch/Metric Scale

MagGrip Gripper™

ITEM NO.				QTY.	LBS.	CU FT.	
7100	100 ft.	3/8 in.	6	24	27.0	1.09	6 50056 07100 6

EVOLUTION GRIPPER

Komelon is excited to announce the release of our NEW Gripper Evolution, closed case long steel tape measure. The Gripper Evolution has a high visibility blade which makes it easier to read and ideal to use in all light conditions. The Gripper Evolution also has a newly designed ABS case with durable rubber grip, that is more ergonomic and functional with both a belt clip and carabineer option to help carry the tape. The Gripper Evolution is the perfect long steel tape for any contractor or other professional who needs accurate measurements.

LONGSTEEL TAPES



NEW Design



Carabineer For Easy Transport And Storage



Locking End Hook Protector

- High Visibility blade
- Rubber Hand Grip
- Durable ABS Construction



ITEM NO.				QTY.	LBS.	CU FT.	
9911	100 ft.	1/2 in.	4	16	22.1	1.02	6 50056 09911 6

KOMELON Long Steel Tapes

LONG Steel Tapes are used by contractors, concrete workers, road construction crews and various other professionals who need accurate measurements.

• Blade Structure of KOMELON Long Steel Tapes

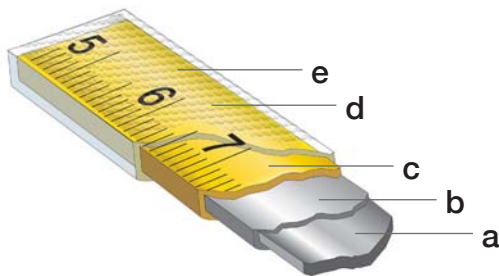

BLADE STRUCTURE OF KOMELON LONG STEEL TAPES

- a. High grade carbon steel
- b. Anti-rust phosphate surface treatment
- c. Strong baked on paint
- d. Transparent nylon coating
- e. Tough embossed finish

• Features and Benefits

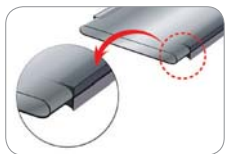

De-burred edges : Rough edges cause corrosion and rust, KOMELON steel tapes with de-burred edge treatment prevents the rough blade edges from causing early corrosion and cracking



Nylon coating : The KOMELON DURA NY-Coat™ nylon coating reduces wear and abrasion. Featuring an embossed finish for added protection and reduced glare. The rust-resistant nylon coating covers the entire blade surface, ensuring long lasting readability and durability.



Heavy duty case construction with impact resistant ABS case or frame. Built-in wire guard to protect case.



Durable rollers guide the blade and prevent twisting.



Versatile ring end hook
(* Add 1 inch when measuring with the ring hook.)

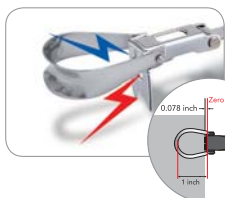

Magnetic end hook allows for easier one person measurement.
Available in MagGrip Gripper™

Zero commencement is inside of the hook. Add 0.078 inch when the magnetic tip is abbutted to a metal surface for an exact measurement.



ACCESSORIES

ACCESSORIES

• Flat Tape

- Flat steel measuring tape with adhesive back
- Adheres to any clean flat surface
- Can be cut to desired length

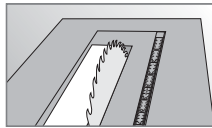
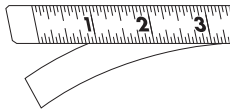

▶ Saw table

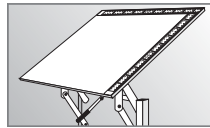

▶ Drafting table

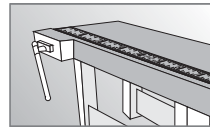

▶ Workbench

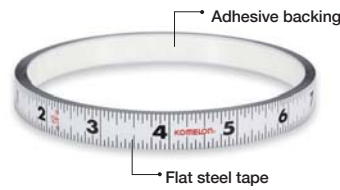

ITEM NO.				QTY.	LBS.	CU FT.	
F12	12 ft.	1/2 in.	6	24	7.0	0.45	6 50056 00012 9

• Torch Safe™

Utility Torch Holder

- Safely stow your torch at home or on the job
- Holds a 14.1oz / 400g Torch
- No more broken or bent torches



ITEM NO.	DESCRIPTION		QTY.	LBS.	CU FT.	
TS12	Utility Torch Holder	4	24	11.3	1.36	6 55348 89012 9

• Keychain Tape



- Slide lock
- Anodized aluminum quick-clip

ITEM NO.				QTY.	LBS.	CU FT.	
4110	10 ft.	1/4 in.	20	160	33.0	1.67	6 50056 04101 6
W4110	10 ft.	1/4 in.	6	36	8.0	0.53	6 50056 04110 8

Private Label Program



For information about our private label program
please contact the Komelon sales dept.
at **888-396-TAPE (8273)** or
by email at **sales@komelonusa.com**

- Leadtime : Upon approval of artwork and placement of a minimum order it takes approximately 4 weeks to receive the labels, Your labels will then be kept on hand to support any re-orders.
- Labeling of all product will be done at Komelon USA upon receipt of labels.

"Great for advertising, giveaways, or everyday items"

MEASURING WHEEL

METER-MAN[®]
by KOMELON[®]



6 SERIES



Twist and Lock Adjustable Aluminum Handle

Center Mounted Handle for Added Stability

Gear-driven, 5 Digit counter Reads up to 10,000 feet

1.6" Wide Wheel for Excellent Straight Line Stability on Hard Surfaces

EXTRA LIGHTWEIGHT AND COMPACT!!

The revolutionary ML6 looks and performs like no other measuring wheel, its wide-wheel stability, excellent balance, and light weight, all combine to offer the best smooth surface, indoor measuring available.

Applications include:

Interior Designer, Homeowners, Indoor Contractors, Home Appraisers, Insurance Adjusters



ITEM NO.	DIAMETER	COLOR			
ML6	2" (Feet/Inches)	High Visibility	1	6	6 55348 10200 0

12 & 18 SERIES



Comfortable Pistol Grip

Adjustable Twist and Lock Handle

Polyvinyl Tread for Improved Traction

Magnifying Lens for Improved Readability

Accurate Gear Driven Counter With Push Button Reset

NEW HIGH VISIBILITY SAFETY COLOR

The 4" and 6" diameter measuring wheel is ideal for indoor measuring on smooth, hard surfaces. The 6" is large enough to be used outdoors on hard surfaces making it versatile. Both are lightweight and compact for convenience.

Applications include:

Adjusters, Appraisers, Decorators, Insurance Agents, Painters, Realtors

12 Series

ITEM NO.	DIAMETER	COLOR			
ML1212	4" (Feet/Inches)	High Visibility	1	8	6 55348 61212 7

18 Series

ITEM NO.	DIAMETER	COLOR			
ML1810	6" (Feet/Tenths)	High Visibility	1	2	6 55348 61810 5
ML1812	6" (Feet/Inches)	High Visibility	1	2	6 55348 61812 9
ML18M	6" (Meters/DM)	High Visibility	1	2	6 55348 61800 6

12 SERIES DUAL WHEEL



ITEM NO.	DIAMETER	COLOR			
MK1212-DW	Dual 4" (Feet/Inches)	High Visibility	1	4	6 55348 81213 8

MEASURE MARKER



5 digit Counter Measures up to 10,000feet

Standard Inverted Aerosol Paint Can (Not Included)

Dual 6" Diameter Wheels for Added Stability

Now you can measure and mark as you walk with the Meter-Man Measure Marker. This handy measuring tool allows you to use the 5 digit counter to accurately measure while marking with the pull of a trigger.

Applications include:

Athletic and Rec. Departments,
Asphalt and Concrete Contractors,
Estimating, Utilities, and many more...

ITEM NO.	DIAMETER	COLOR			
MKMM12	6" (Feet/Inches)	High Visibility	1	2	6 55348 80613 7

31 & 45 SERIES

The 10" and 14.3" diameter wheels are the most popular wheels in the market place. The 10" is versatile enough for indoor and outdoor use, while the 14.3" is perfect for almost any outdoor use.

The wheels are covered with a composite tread to provide improved traction on smoother surfaces. These are the perfect wheel for almost any application.

Applications include:

Athletic and Rec. Departments,
Concrete and Asphalt Contractors,
Estimating, Fencing, Grounds
Maintenance, Irrigation,
Surveying

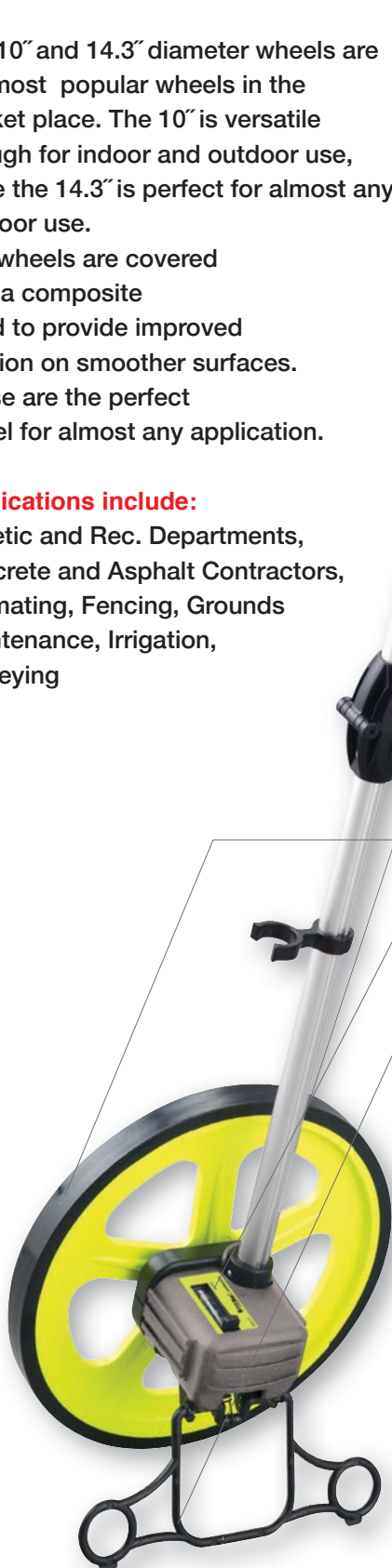

Comfortable Pistol Grip Handle

Protective Rubber Counter Jacket



Folding Shaft

Gear-Driven, 5 digit Counter Reads up to 10,000 Feet

Accurate Gear Driven Counter with Push Button Reset

Polyvinyl Tread for Improved Traction

Kickstand Molded into Counter Housing

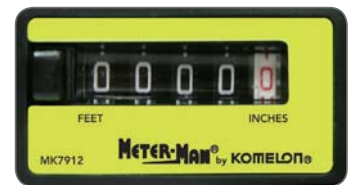

31 Series

ITEM NO.	DIAMETER	COLOR			
MK3110	10" (Feet/Tenths)		1	2	6 55348 83110 8
MK3112	10" (Feet/Inches)	High Visibility	1	2	6 55348 83112 2
MK31M	10" (Meter/DM)		1	2	6 55348 83100 9

45 Series

ITEM NO.	DIAMETER	COLOR			
MK4512	14.3" (Feet/Inches)	High Visibility	1	2	6 55348 84512 9
MK45M	14.3" (Meters/DM)		1	2	6 55348 84500 6

60 & 79 SERIES

The 19" and 25" diameter wheels are designed to be used in the roughest terrain and for measuring large areas. The 19" is covered with a composite tread which is also perfect for smooth surfaces, while the 25" has a polystyrene wheel that is more suited for very rough surfaces and is commonly used to compute acreage using the 6.6 foot circumference.

Applications Include (60 Series):

Athletic field and Rec. depts., Concrete and Asphalt Contractors, Estimating, Fencing, Grounds Maintenance, Survey

Applications Include (79 Series):

Agricultural, Conservation, Forestry, Utilities

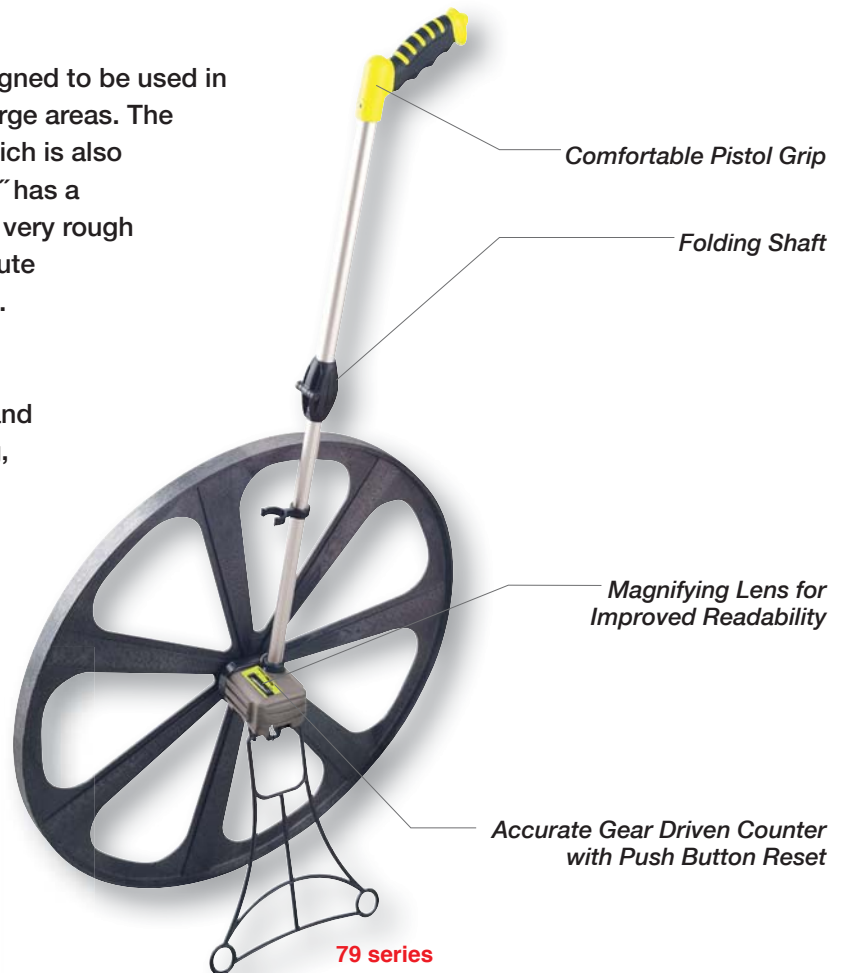

60 series

Protective Rubber Counter Jacket



60 Series

ITEM NO.	DIAMETER	COLOR			
MK6012	19" (Feet/Inches)	High Visibility	1	2	6 55348 86012 2
MK60M	19" (Meters/DM)	High Visibility	1	2	6 55348 86000 9

79 Series

ITEM NO.	DIAMETER	COLOR			
MK7912	25" (Feet/Inches)	High Visibility	1	2	6 55348 87912 4
MK79M	25" (Meters/DM)	High Visibility	1	2	6 55348 87900 1

ELECTRONIC WHEEL

The Electronic Measuring Wheel features easy to use electronic counters. These are easy-to-read LCD displays that show distances in feet or meters simply by pushing a button.

LCD Display

Shows six digits or four whole numbers and two decimals.

Operates in forward and reverse



ON/CLR Button

This function key turns the electronics on when pressed once and clears the existing reading when pressed a second time. If the wheel controls are not operated for a period of three minutes, the unit will turn off to conserve battery life, but will continue to retain data.

#1/#2

This button alternates the display between #1 or #2 data.

M/FT

Select from 3 measuring modes:
 Feet & Inches (000'00")
 Feet & Hundredths of a foot (0000.00)
 Meters & Centimeters (0000.00)

HLD/CLR

Pressing this button once holds the #1 or #2 reading. Pressing a second time clears the reading and hold.

Adjustable Twist and Lock Handle

Polyvinyl Tread for Improved Traction

Electronic Wheels Feature Electronic Counters Located at The End of The Handle Shaft

Electronic Measuring Wheel Series

ITEM NO.	DIAMETER	COLOR			
EW31	10" (Feet&Meter)	High Visibility	1	2	6 55348 90310 2



KOMELON
SAW

2-CUT

Komelon is excited to announce the kickoff of our new innovative 2-Cut folding saw. This saw delivers 2 blades in 1, the perfect tool for any homeowner or professional. One of the blades is an aggressive cut, ideal for any large pruning or tree cutting job. The 2nd blade offers a smoother more controlled cut, ideal for cutting through smaller branches, processed wood, PVC material or any other cutting application excluding metal. The blades ergonomic handle consists of a dual injected plastic with a comfortable rubber over molding. Komelon's 2-Cut saw will address all your cutting needs in one compact quality tool.

NEW
Design



AGGRESSIVE

Length TPI Pitch

8"/210mm 6.5 0.157"/4mm



SMOOTH

Length TPI Pitch

8"/210mm 12 0.085"/2.15mm



ITEM NO.					
	QTY.	QTY.	LBS.		
FT-210	0.35	6	24	14.2	6 50056 40210 6

UTILITY SAW

UTILITY SAW



- Japanese High Carbon Steel For Extra Sharp Teeth & Maximum Blade Durability
- Ultralight Aluminum Handle
- Hard Chrome Plated
- Ergonomic Non-Slip Grip



PVC PIPE



WOOD WORKING



PRUNING











CAMPING



US-210D

Replacement Blade Only



ITEM NO.								
	QTY.	QTY.	LBS.					
US-210	8" / 210mm	10.5	0.094" / 2.4mm	0.35	4	24	14.2	6 50056 40210 7
US-210B [®]	8" / 210mm	10.5	0.094" / 2.4mm	0.06	20	80	-	6 50056 40219 0
US-210D	8" / 210mm	10.5	0.094" / 2.4mm	0.35	12	24	-	6 50056 43210 4

CARPENTER SAW



KOMELON SAW

Komelon is proud to introduce our NEW SpeedCut™ Carpenter Saws. These saws are ideal for any master woodcrafter or homeowner. The pull saw style refers to the functionality of the saw, which is to cut on the pullback motion. The pull saw technique ensures the blade remains straight, eliminating the bending and binding of conventional push saws. The thin blade design produces less sawdust for a more precise cut with a fraction of the power needed for conventional saws. The flexibility of the blade also allows for easier access in otherwise hard to reach places.

Traditional Handle

NEW
Design



Pistol Grip Handle



Replacement Blade Only



ITEM NO.								
					QTY.	QTY.	LBS.	
OS-265	10-1/2"/265mm	14.5	0.068"/1.75mm	0.63	6	24	25	6 50056 50265 4
PG-265	10-1/2"/265mm	14.5	0.068"/1.75mm	0.48	6	24	13.4	6 50056 51265 3
OS(PG)-265B [Ⓡ]	10-1/2"/265mm	14.5	0.068"/1.75mm	0.22	10	50	-	6 50056 42659 2

FOLDING SAW



Tri-Edge performs clean and smooth cut with out scratching the surface.



Rust resistant hard chromed blade made of high carbon steel.



Ultra high frequency heated teeth are hardened, which increases the durability of the saw's cutting edge.



Tapered blade provides a smoother, faster cutting performance with the least amount of harm to the cut branch.



Replacement blades available

• FS Series



Bulk Packaging Replacement Blade Only



ITEM NO.									
		FT	IN	IN		QTY.	QTY.	LBS.	
FS-180	7" / 180mm	6.5	0.157" / 4mm	0.40	12	24	12.2	6 50056 12180 0	
FS-180B [®]	7" / 180mm	6.5	0.157" / 4mm	0.08	20	80	-	6 50056 12189 3	

FOLDING SAW

● FB Series



Replacement Blade Only

ITEM NO.								
		T ^{1/2} -1	F-P-1		QTY.	QTY.	LBS.	
FB-180	7" / 180mm	6.5	0.157" / 4mm	0.46	4	24	16.0	6 50056 10180 2
FB-210	8" / 210mm	6.5	0.157" / 4mm	0.57	4	24	18.5	6 50056 10210 6
FB-240	9-1/2" / 240mm	6.5	0.157" / 4mm	0.66	4	24	21.5	6 50056 10240 3
FB-180B [Ⓡ]	7" / 180mm	6.5	0.157" / 4mm	0.09	20	80	-	6 50056 10189 5
FB-210B [Ⓡ]	8" / 210mm	6.5	0.157" / 4mm	0.11	20	80	-	6 50056 10219 9
FB-240B [Ⓡ]	9-1/2" / 240mm	6.5	0.157" / 4mm	0.12	20	80	-	6 50056 10249 6

● FC Series



Replacement Blade Only

ITEM NO.								
		T ^{1/2} -1	F-P-1		QTY.	QTY.	LBS.	
FC-180	7" / 180mm	6.5	0.157" / 4mm	0.46	4	24	16.0	6 50056 13180 9
FC-210	8" / 210mm	6.5	0.157" / 4mm	0.55	4	24	19.0	6 50056 13210 3
FC-180B [Ⓡ]	7" / 180mm	6.5	0.157" / 4mm	0.09	20	80	-	6 50056 13189 2
FC-210B [Ⓡ]	8" / 210mm	6.5	0.157" / 4mm	0.11	20	80	-	6 50056 13219 6

PRUNING SAW

● PWC series



Replacement Blade Only



ITEM NO.						QTY.		QTY.	LBS.	
PWC-270	10-1/2" / 270mm	6.5	0.157" / 4mm	0.83	4	24	15.3	6 50056 22270 5		
PWC-300	12" / 300mm	6.5	0.157" / 4mm	0.87	4	24	15.7	6 50056 22300 9		
PWC-350	14" / 350mm	6.5	0.157" / 4mm	0.90	4	24	16.7	6 50056 22350 4		
PWC-270B ^e	10-1/2" / 270mm	6.5	0.157" / 4mm	0.16	20	80	-	6 50056 22279 8		
PWC-300B ^e	12" / 300mm	6.5	0.157" / 4mm	0.18	20	80	-	6 50056 22309 2		
PWC-350B ^e	14" / 350mm	6.5	0.157" / 4mm	0.22	20	80	-	6 50056 22359 7		

● CWC series



Replacement Blade Only



ITEM NO.						QTY.		QTY.	LBS.	
CWC-330	13" / 330mm	6.5	0.157" / 4mm	0.95	4	24	27.0	6 50056 32330 3		
CWC-330B ^e	13" / 330mm	6.5	0.157" / 4mm	0.25	20	80	-	6 50056 32339 6		



USA Division

BUSINESS TERMS

PRICES:	Subject to change without notice. Orders accepted only on the basis of prices in effect on date of shipment. all prices shown reflect individual unit price.
PAYMENT TERMS:	Terms are Net 30 days.
MINIMUMS:	minimum order for all accounts is \$250 - Tape measures + wheels minimum order for all accounts is \$150 - Pruning saws only
FREIGHT:	Prepaid at \$500.00 net within the continental U.S. and \$750 to Canada - tape measures + wheels Prepaid at \$150.00 within the continental U.S. and \$250 to Canada - Pruning saws only Prepaid at \$2500.00 net Alaska, Hawaii, Puerto Rico.
PACKAGING	Weight shown on the packing slip is based on current policy and can change without notice. In the event of a shortage or other discrepancy, the weight of the shipment will govern. KOMELON USA DIVISION RESERVES THE RIGHT TO INCREASE OR DECREASE THE QUANTITY AS ORDERED TO NEAREST INNER PACK OR MASTER PACK QUANTITY FOR SHIPMENT.
RETURN POLICY:	KOMELON USA DIVISION Products are not to be returned unless prior authorization has been received from our sales department. Wholesalers and dealers are not authorized to make replacements. When returns have been authorized, they should be sent to: KOMELON USA DIVISION 301 Commerce Place Waukesha, WI 53186-1045 RETURNS MUST BE SENT FREIGHT PREPAID Credit for authorized returned will be issued at the products current value less applicable return freight costs and packaging.
ORDERING INFORMATION:	KOMELON USA DIVISION 301 Commerce Place Waukesha, WI 53186-1045 Phone: (262) 524-TAPE (8273), Fax: (262) 524-8293 Customer Service Order Dept. : 1-888-396-TAPE (8273)
MAILING ADDRESS:	P.O. Box 1045 Waukesha, WI 53187-1045
MANUFACTURING HEADQUARTERS:	KOMELON CORP. P.O. Box SAHA 50, Janglim-2dong, Saha-ku, Busan Korea Phone: (82)-51-290-3100, Fax: (82)-51-290-3119 http://www.komelonusa.com
PAYMENT REMITTANCE:	KOMELON USA DIVISION 301 Commerce Place P.O. Box 1045 Waukesha, WI 53187-1045 http://www.komelonusa.com
CONTACT US AT:	sales@komelonusa.com
SEE US AT:	www.komelonusa.com

KOMELON®

USA Division



KOMELON® USA Division

301 COMMERCE PLACE, P.O. BOX 1045 WAUKESHA, WISCONSIN 53186-1045
PH. 262/524-TAPE (8273) TOLL FREE 1-888/396-TAPE (8273) FAX : 262/524-8293
E-mail : sales@komelonusa.com www.komelonusa.com

Printed in KOREA APRIL. 2017 graphic designed by Joseph