

Professional Meter Stick - 39.37" Length

39.37" = 1 Meter

- Bright anodized extruded aluminum
- Easy-to-read black graduations
- Convenient metric conversion tables printed on back

No.	Description
SLM39	Meter Stick = 39.37"



Professional Rules or Yard Sticks

- Bright anodized extruded aluminum
- Easy-to-read black graduations
- Rules are reverse reading

No.	Description
SLAR12	Rule - 12"x1-1/8" (304.8mm x 28.575mm)
SLAR18	Rule - 18"x1-1/8" (457.2mm x 28.575mm)
SLAR24	Rule - 24"x1-1/8" (609.6mm x 28.575mm)
SLAYS36	Yard Stick 1 Sided - 36"x1-1/8" (914.4mm x 28.575mm)
SLAYS362	Yard Stick 2 Sided - 36"x1-1/8" (914.4mm x 28.575mm)



Professional Straightedges

7 Sizes 18" - 96"

"T" Denotes THICK 3/16" Blade

- Bright anodized extruded aluminum
- Easy-to-read black graduations
- Reverse reading

No.	Description
SLASE18	18"x2"x1/8" (457.2mm x 50.8mm x 3.175mm)
SLASE18T	18"x2"x3/16" (457.2mm x 50.8mm x 4.76mm)
SLASE24	24"x2"x1/8" (609.6mm x 50.8mm x 3.175mm)
SLASE24T	24"x2"x3/16" (609.6mm x 50.8mm x 4.76mm)
SLASE36	36"x2"x1/8" (914.4mm x 50.8mm x 3.175mm)
SLASE36T	36"x2"x3/16" (914.4mm x 50.8mm x 4.76mm)
SLASE48	48"x2"x1/8" (1219.2mm x 50.8mm x 3.175mm)
SLASE48T	48"x2"x3/16" (1219.2mm x 50.8mm x 4.76mm)
SLASE60	60"x2"x1/8" (1524mm x 50.8mm x 3.175mm)
SLASE72	72"x2"x1/8" (1828.8mm x 50.8mm x 3.175mm)
SLASE72T	72"x2"x3/16" (1828.8mm x 50.8mm x 4.76mm)
SLASE96	96"x2"x1/8" (2438.4mm x 50.8mm x 3.175mm)

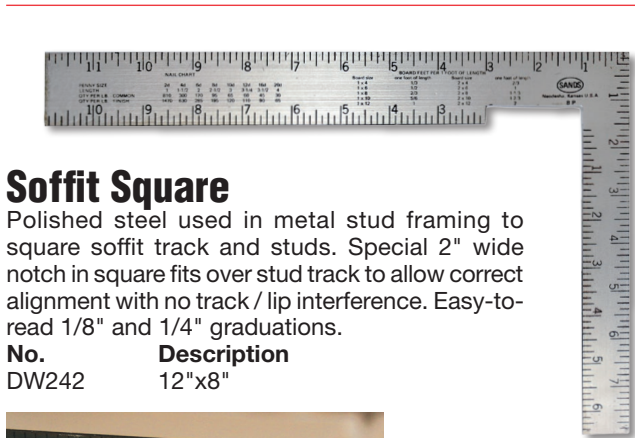

Soffit Square

Polished steel used in metal stud framing to square soffit track and studs. Special 2" wide notch in square fits over stud track to allow correct alignment with no track / lip interference. Easy-to-read 1/8" and 1/4" graduations.

No.	Description
DW242	12"x8"

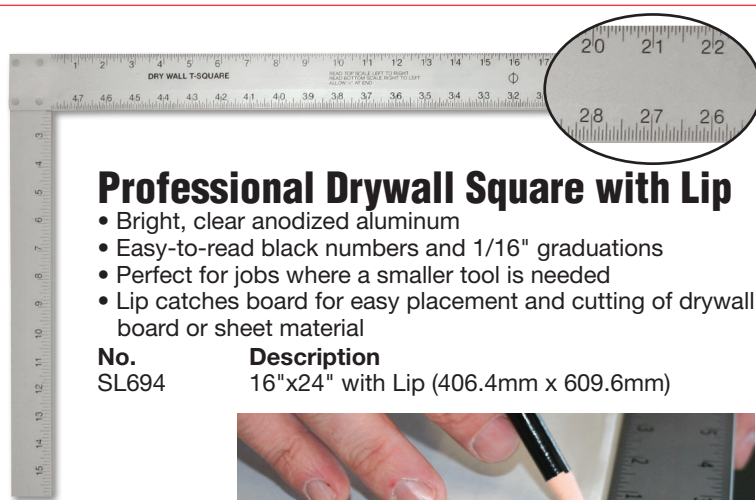
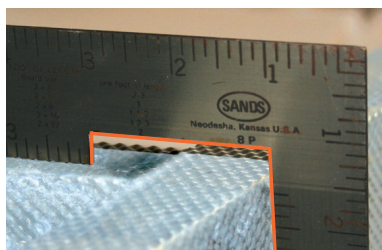

Professional Drywall Square with Lip

- Bright, clear anodized aluminum
- Easy-to-read black numbers and 1/16" graduations
- Perfect for jobs where a smaller tool is needed
- Lip catches board for easy placement and cutting of drywall board or sheet material

No.	Description
SL694	16"x24" with Lip (406.4mm x 609.6mm)

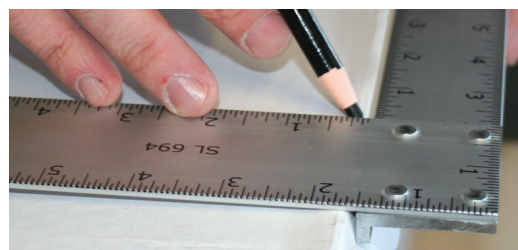

SANDS T-SQUARES

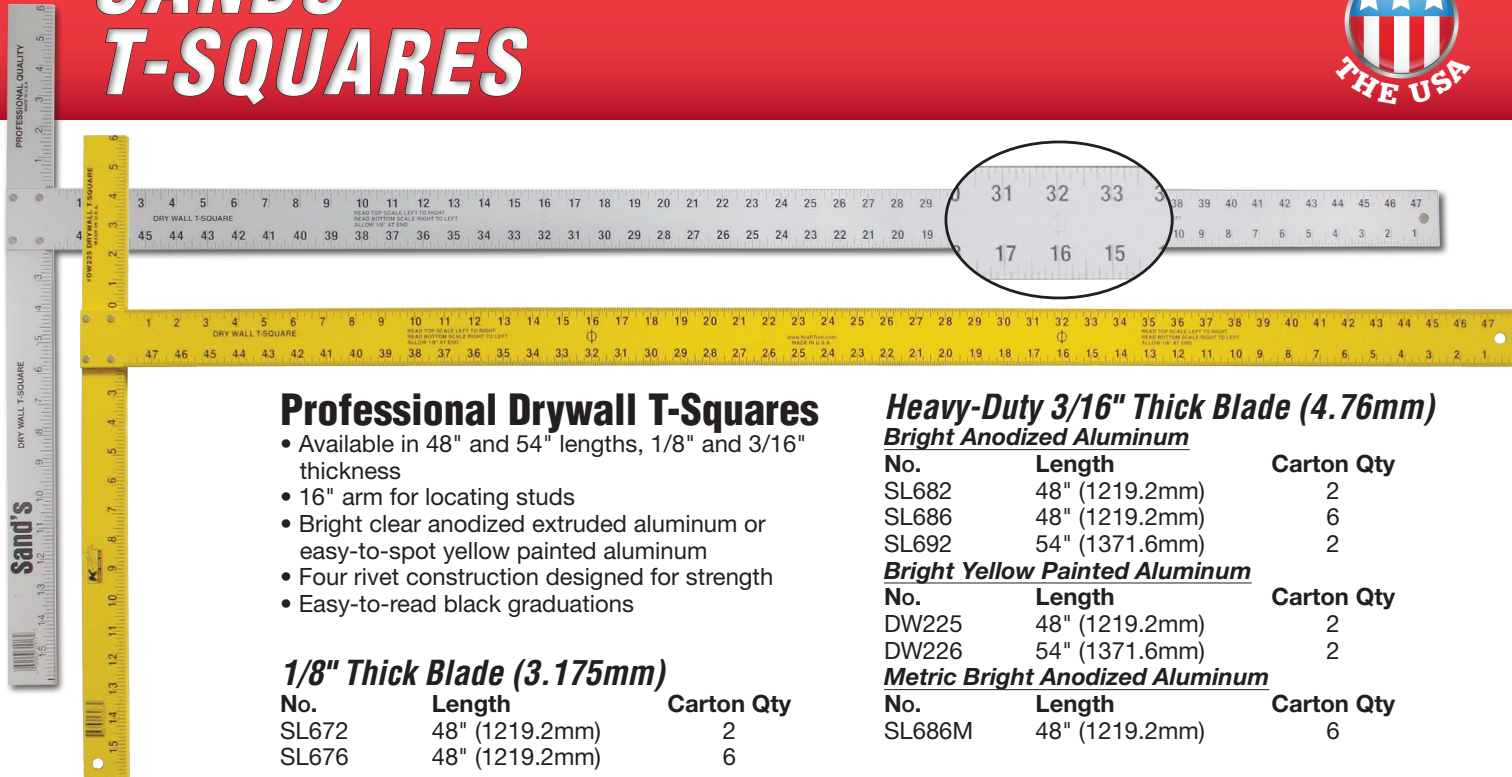

Professional Drywall T-Squares

- Available in 48" and 54" lengths, 1/8" and 3/16" thickness
- 16" arm for locating studs
- Bright clear anodized extruded aluminum or easy-to-spot yellow painted aluminum
- Four rivet construction designed for strength
- Easy-to-read black graduations

1/8" Thick Blade (3.175mm)

No.	Length	Carton Qty
SL672	48" (1219.2mm)	2
SL676	48" (1219.2mm)	6

Heavy-Duty 3/16" Thick Blade (4.76mm) Bright Anodized Aluminum

No.	Length	Carton Qty
SL682	48" (1219.2mm)	2
SL686	48" (1219.2mm)	6
SL692	54" (1371.6mm)	2

Bright Yellow Painted Aluminum

No.	Length	Carton Qty
DW225	48" (1219.2mm)	2
DW226	54" (1371.6mm)	2

Metric Bright Anodized Aluminum

No.	Length	Carton Qty
SL686M	48" (1219.2mm)	6

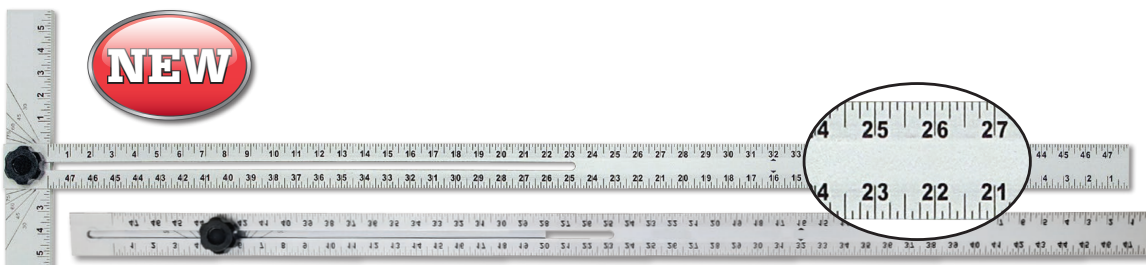

Professional Adjustable T-Square

- Adjusts to set 30°, 45°, 60°, 75°, and 90° angles
- 16" stud markings
- Lip on arm catches material for easy cutting and scoring
- Bright anodized extruded aluminum, 1/4" thick
- Plastic knob adjusts angle and length
- Collapse for easy transportation

No.	Length	Carton Qty
SL680*	48"	4



T-Square collapsed

Detail of adjustable angle blade

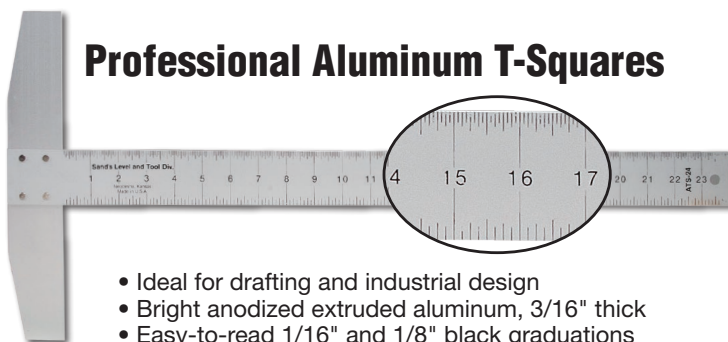

Professional Aluminum T-Squares

- Ideal for drafting and industrial design
- Bright anodized extruded aluminum, 3/16" thick
- Easy-to-read 1/16" and 1/8" black graduations
- Accurate 90 degree angle

No.	Description
SLATS24	24"x2" (609.6mm x 50.8mm)
SLATS36	36"x2" (914.4mm x 50.8mm)
SLATS48	48"x2" (1219.2mm x 50.8mm)

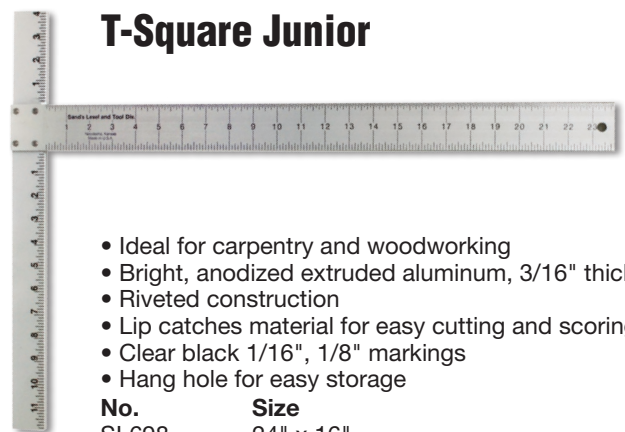









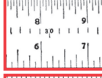

T-Square Junior

- Ideal for carpentry and woodworking
- Bright, anodized extruded aluminum, 3/16" thick
- Riveted construction
- Lip catches material for easy cutting and scoring
- Clear black 1/16", 1/8" markings
- Hang hole for easy storage

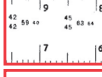
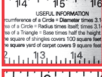
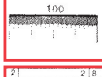
No.	Size
SL698	24" x 16"

*See page 178

KEY TO FEATURES *Features listed below by Squares*

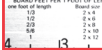
	A. Rafter Framing Rule		H. Wood Screw Drill Size
	B. Octagon Scale		J. Protractor
	C. Brace Measure		K. Useful Information
	D. 1/100 Scale		L. Nail Information
	E. Essex Board Measure		M. Decimal Equivalents
	F. Reverse Reading Rule		N. Screw Thread Gauge
	G. Metric Equivalents		O. Board Foot Table

CARPENTER SQUARES

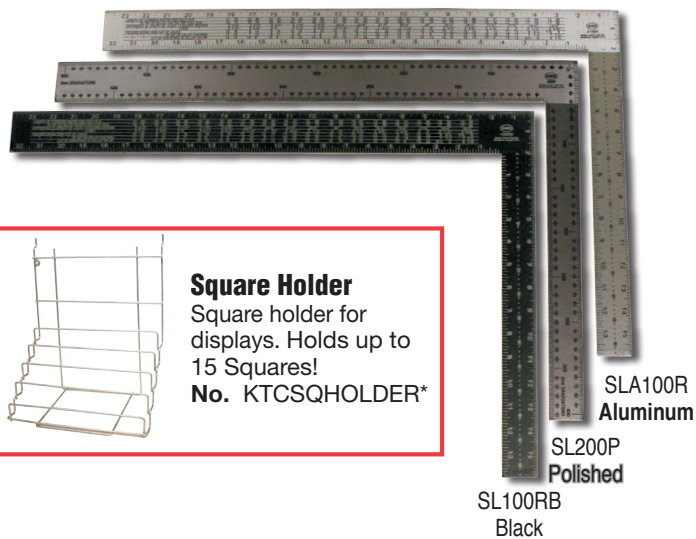

Square Holder
Square holder for displays. Holds up to 15 Squares!
No. KTCSQHOLDER*

SLA100R Aluminum
SL200P Polished
SL100RB Black

Etched Numbers *Long lasting, easy-to-read permanent etched numbers*

Features: A, B, C, D, E / Etched **Multiple Features**
Graduations: 1/16", 1/10", 1/12", 1/8"
No. Size Description
SL100RB 16"x24" Rafter Square - Steel - Black
SL100RP 16"x24" Rafter Square - Steel - Polished
SLA100R 16"x24" Rafter Square - Aluminum

Features: Rafter, Metric / Etched
Graduations: Centimeters
No. Size Description
SL200P 16"x24" Rafter Square Metric - Steel - Polished

Features: A, Rafter / Etched
Graduations: 1/16", 1/8", Centimeters E/M = English/Metric
No. Size Description
SL300P 16"x24" E/M Rafter Square - Steel - Polished

Features: A, Rafter / Etched
Graduations: 1/8"
No. Size Description
SLSC2B 16"x24" Rafter Square - Steel - Black

Features: H, K, L, O / Etched **Multiple Features**
Graduations: 1/8", 1/4"
No. Size Description
SL8B 8"x12" Square - Steel - Black
SL8P 8"x12" Square - Steel - Polished

Features: F / Etched
Graduations: 1/8", 1/4"
No. Size Description
SLSC1P 16"x24" Standard Square - Steel - Polished
SLSC1A 16"x24" Standard Square - Aluminum

Contractor Angle - Stair Gauge

- Attach to metal carpenter square for accurate, repeat angle cuts on rafters, stairs, etc.
- Solid brass

No.	Description
SL460	2 per card

Printed Numbers *General purpose squares, with easy-to-read numbers*

Features: G, H, J, K, L, M, N, O / Printed **Multiple Features**
Graduations: 1/8"
No. Size Description
SLSC4P 16"x24" Printed Square - Steel - Polished
SLSC4A 16"x24" Printed Square - Aluminum

Features: Standard / Printed
Graduations: 1/16", 1/8"
No. Size Description
SLSC7B 8"x12" Printed Square - Steel - Black

Features: A, B, C, E / Printed **Multiple Features**
Graduations: 1/16", 1/12", 1/10", 1/8"
No. Size Description
SLSC6B 16"x24" Printed Square - Steel - Black
SLSC6A 16"x24" Printed Square - Aluminum

Etched Numbers *Long lasting, easy-to-read permanent etched numbers*

Features: Etched
Graduations: 1/8", millimeters E/M = English/Metric
No. Size Description
SL400P 16"x24" English / Metric - Steel - Polished
SL800P 8"x12" English / Metric - Steel - Polished

W. Rose™

• SINCE 1798 •

THE WORLD'S FINEST BRICKLAYER'S TOOLS

SINGLE PIECE FORGED
FOR STRENGTH

FORGED STEEL

The blade and shank are forged from a single piece of uniquely formulated carbon steel for extra toughness. Forging also assures product consistency.

HEAT TEMPERED

Blades are heat tempered with a special time-tested process to ensure uniform blade hardness.



FLEXIBILITY

W. Rose™ features a tapered ground blade for flexibility. Blades are made in standard or limber weights.

STRENGTH

The forged steel blade and shank offer strength and integrity with no internal voids created by welding pieces together. Forged steel will not weaken or crack.

HAND POLISHED

Each blade is carefully hand polished to keep mortar centered on the blade and resist sliding.

SHANK ANGLE

The standard shank angle is specifically balanced to reduce wrist fatigue. Many of our popular trowel patterns are also available in low lift shanks for your comfort.

INSPECTION

Every trowel is inspected, keeping in mind the high quality standards of the W. Rose™ legacy. They also undergo testing for blade hardness and consistent size.

HANDLE STYLES

Four styles of handles are available on most W. Rose™ trowels - ProForm® soft grip, leather, two sizes of wood and plastic. All handles are specially contoured for a comfortable grip.

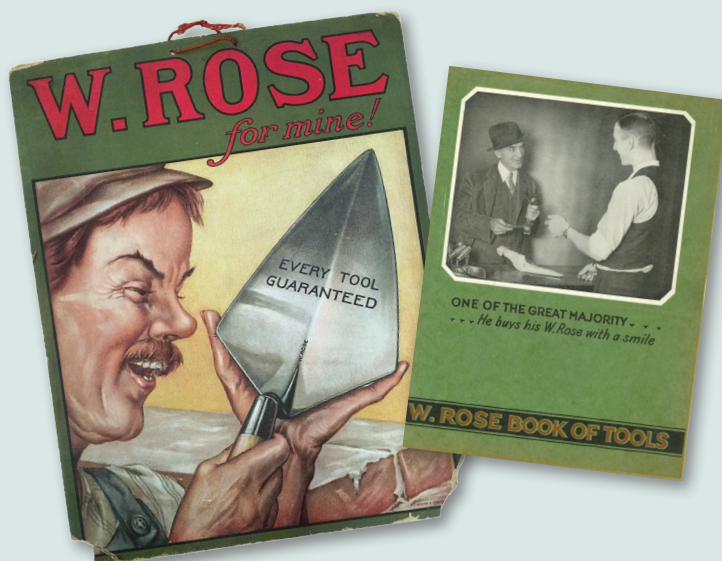

Left: A hanging W. Rose™ store sign from the 1930s
Right: W. Rose™ Book of Tools from 1929

ROSE TOOLS ENDURE

For over 200 years W. Rose™ has been the premier brand for the highest quality of masonry tools. William Rose established the company in 1798 near Philadelphia in Blockley Township, Pennsylvania. This blacksmith shop spent much of the early 1800s making tools, cavalry sabers and officer swords for the U.S. Army. In 1864 W. Rose™ began specializing in quality edged tools, knives and their signature brick trowel.

In 2001, Kraft Tool Co.® acquired W. Rose™ and remains dedicated to maintaining the legendary quality of its masonry products.

**As they have for 220 years,
Rose Tools Endure**



W. Rose Online

NARROW LONDON PATTERN



This diamond-heeled blade carries mortar away from the handle. The narrow size is good for general masonry and brick projects. The Narrow London blade easily spreads mortar for projects such as veneering. Single piece forged steel.

ProForm® Soft Grip Handle

Standard Shank - Narrow London

No.	Blade	Heel Width
RO116-9SH	9"	4-3/16"
RO116-9-1/2SH	9-1/2"	4-1/4"
RO116-10SH	10"	4-1/2"
RO116-10-1/2SH	10-1/2"	4-5/8"
RO116-11SH	11"	4-3/4"
RO116-11-1/2SH	11-1/2"	4-7/8"
RO116-12SH	12"	5"
RO116-12-1/2SH	12-1/2"	5-1/4"
RO116-13SH	13"	5-3/8"



See page 114 for
limber weight
trowel blades



MADE IN THE USA
SINCE 1798



Wood Handle

Standard Shank - Narrow London

No.	Blade	Heel Width	Handle Size
RO116-9	9"	4-3/16"	6"
RO116-9-1/2	9-1/2"	4-1/4"	6"
RO116-10	10"	4-1/2"	6"
RO116-10-1/2	10-1/2"	4-5/8"	6"
RO116-11	11"	4-3/4"	6"
RO116-11-1/2	11-1/2"	4-7/8"	6"
RO116-12	12"	5"	6"
RO116-12-1/2	12-1/2"	5-1/4"	6"
RO116-13	13"	5-3/8"	6"
RO416-9	9"	4-3/16"	5"
RO416-9-1/2	9-1/2"	4-1/4"	5"
RO416-10	10"	4-1/2"	5"
RO416-10-1/2	10-1/2"	4-5/8"	5"
RO416-11	11"	4-3/4"	5"
RO416-11-1/2	11-1/2"	4-7/8"	5"
RO416-12	12"	5"	5"
RO416-12-1/2	12-1/2"	5-1/4"	5"
RO416-13	13"	5-3/8"	5"



Low Lift Shanks

Low lift shank trowels have a lower handle angle as preferred by some masons. Comfortable position for your hand and wrist.

Low Lift Shank - Narrow London Wood Handle

No.	Blade	Heel Width	Handle Size
RO186-9	9"	4-3/16"	6"
RO186-9-1/2	9-1/2"	4-1/4"	6"
RO186-10	10"	4-1/2"	6"
RO186-10-1/2	10-1/2"	4-5/8"	6"
RO186-11	11"	4-3/4"	6"
RO186-11-1/2	11-1/2"	4-7/8"	6"
RO186-12	12"	5"	6"
RO186-12-1/2	12-1/2"	5-1/4"	6"
RO186-13	13"	5-3/8"	6"
RO486-9	9"	4-3/16"	5"
RO486-9-1/2	9-1/2"	4-1/4"	5"
RO486-10	10"	4-1/2"	5"
RO486-10-1/2	10-1/2"	4-5/8"	5"
RO486-11	11"	4-3/4"	5"
RO486-11-1/2	11-1/2"	4-7/8"	5"
RO486-12	12"	5"	5"
RO486-12-1/2	12-1/2"	5-1/4"	5"
RO486-13	13"	5-3/8"	5"

Leather Handle

Standard Shank - Narrow London

No.	Blade	Heel Width
RO316-9	9"	4-3/16"
RO316-9-1/2	9-1/2"	4-1/4"
RO316-10	10"	4-1/2"
RO316-10-1/2	10-1/2"	4-5/8"
RO316-11	11"	4-3/4"
RO316-11-1/2	11-1/2"	4-7/8"
RO316-12	12"	5"
RO316-12-1/2	12-1/2"	5-1/4"
RO316-13	13"	5-3/8"



Low Lift Shank - Narrow London Leather Handle

No.	Blade	Heel Width
RO386-9	9"	4-3/16"
RO386-9-1/2	9-1/2"	4-1/4"
RO386-10	10"	4-1/2"
RO386-10-1/2	10-1/2"	4-5/8"
RO386-11	11"	4-3/4"
RO386-11-1/2	11-1/2"	4-7/8"
RO386-12	12"	5"
RO386-12-1/2	12-1/2"	5-1/4"
RO386-13	13"	5-3/8"

Plastic Handle

Standard Shank - Narrow London

No.	Blade	Heel Width
RO1416-9	9"	4-3/16"
RO1416-9-1/2	9-1/2"	4-1/4"
RO1416-10	10"	4-1/2"
RO1416-10-1/2	10-1/2"	4-5/8"
RO1416-11	11"	4-3/4"
RO1416-11-1/2	11-1/2"	4-7/8"
RO1416-12	12"	5"
RO1416-12-1/2	12-1/2"	5-1/4"
RO1416-13	13"	5-3/8"



Low Lift Shank - Narrow London Plastic Handle

No.	Blade	Heel Width
RO1486-9	9"	4-3/16"
RO1486-9-1/2	9-1/2"	4-1/4"
RO1486-10	10"	4-1/2"
RO1486-10-1/2	10-1/2"	4-5/8"
RO1486-11	11"	4-3/4"
RO1486-11-1/2	11-1/2"	4-7/8"
RO1486-12	12"	5"
RO1486-12-1/2	12-1/2"	5-1/4"
RO1486-13	13"	5-3/8"

WIDE LONDON PATTERN

The wide diamond-shaped blade carries the mortar towards the blade tip. The Wide London pattern holds more mortar making it a popular pattern for concrete block and stonework. Single piece forged steel for strength.



ProForm® Soft Grip Handle

Standard Shank - Wide London

No.	Blade	Heel Width
RO112-9SH	9"	5-1/4"
RO112-9-1/2SH	9-1/2"	5-3/8"
RO112-10SH	10"	5-1/2"
RO112-10-1/2SH	10-1/2"	5-1/2"
RO112-11SH	11"	5-5/8"
RO112-11-1/2SH	11-1/2"	5-3/4"
RO112-12SH	12"	5-13/16"

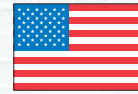

MADE IN THE USA
SINCE 1798



Wood Handle

Standard Shank - Wide London

No.	Blade	Heel Width	Handle Size
RO112-9	9"	5-1/4"	6"
RO112-9-1/2	9-1/2"	5-3/8"	6"
RO112-10	10"	5-1/2"	6"
RO112-10-1/2	10-1/2"	5-1/2"	6"
RO112-11	11"	5-5/8"	6"
RO112-11-1/2	11-1/2"	5-3/4"	6"
RO112-12	12"	5-13/16"	6"
RO412-9	9"	5-1/4"	5"
RO412-9-1/2	9-1/2"	5-3/8"	5"
RO412-10	10"	5-1/2"	5"
RO412-10-1/2	10-1/2"	5-1/2"	5"
RO412-11	11"	5-5/8"	5"
RO412-11-1/2	11-1/2"	5-3/4"	5"
RO412-12	12"	5-13/16"	5"

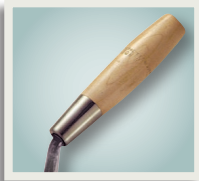

Low Lift Shanks

Low lift shank trowels have a lower handle angle as preferred by some masons. Comfortable position for your hand and wrist.

Low Lift Shank - Wide London Wood Handle

No.	Blade	Heel Width	Handle Size
RO182-9	9"	5-1/4"	6"
RO182-9-1/2	9-1/2"	5-3/8"	6"
RO182-10	10"	5-1/2"	6"
RO182-10-1/2	10-1/2"	5-1/2"	6"
RO182-11	11"	5-5/8"	6"
RO182-11-1/2	11-1/2"	5-3/4"	6"
RO182-12	12"	5-13/16"	6"
RO482-9	9"	5-1/4"	5"
RO482-9-1/2	9-1/2"	5-3/8"	5"
RO482-10	10"	5-1/2"	5"
RO482-10-1/2	10-1/2"	5-1/2"	5"
RO482-11	11"	5-5/8"	5"
RO482-11-1/2	11-1/2"	5-3/4"	5"
RO482-12	12"	5-13/16"	5"

Leather Handle

Standard Shank - Wide London

No.	Blade	Heel Width
RO312-9	9"	5-1/4"
RO312-9-1/2	9-1/2"	5-3/8"
RO312-10	10"	5-1/2"
RO312-10-1/2	10-1/2"	5-1/2"
RO312-11	11"	5-5/8"
RO312-11-1/2	11-1/2"	5-3/4"
RO312-12	12"	5-13/16"

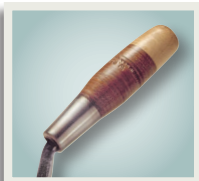

Low Lift Shank - Wide London Leather Handle

No.	Blade	Heel Width
RO382-9	9"	5-1/4"
RO382-9-1/2	9-1/2"	5-3/8"
RO382-10	10"	5-1/2"
RO382-10-1/2	10-1/2"	5-1/2"
RO382-11	11"	5-5/8"
RO382-11-1/2	11-1/2"	5-3/4"
RO382-12	12"	5-13/16"

Plastic Handle

Standard Shank - Wide London

No.	Blade	Heel Width
RO1412-9	9"	5-1/4"
RO1412-9-1/2	9-1/2"	5-3/8"
RO1412-10	10"	5-1/2"
RO1412-10-1/2	10-1/2"	5-1/2"
RO1412-11	11"	5-5/8"
RO1412-11-1/2	11-1/2"	5-3/4"
RO1412-12	12"	5-13/16"

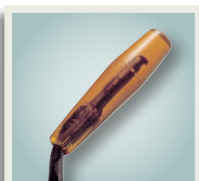

Low Lift Shank - Wide London Plastic Handle

No.	Blade	Heel Width
RO1482-9	9"	5-1/4"
RO1482-9-1/2	9-1/2"	5-3/8"
RO1482-10	10"	5-1/2"
RO1482-10-1/2	10-1/2"	5-1/2"
RO1482-11	11"	5-5/8"
RO1482-11-1/2	11-1/2"	5-3/4"
RO1482-12	12"	5-13/16"

PHILADELPHIA PATTERN

The square heel on this trowel holds the most mortar and has become the most popular trowel to use with block. Single piece forged steel for strength.



MADE IN THE USA
SINCE 1798



ProForm® Soft Grip Handle

Standard Shank - Philadelphia

No.	Blade	Heel Width
RO110-9SH	9"	5-1/8"
RO110-9-1/2SH	9-1/2"	5-3/16"
RO110-10SH	10"	5-1/4"
RO110-10-1/2SH	10-1/2"	5-3/8"
RO110-11SH	11"	5-7/16"
RO110-11-1/2SH	11-1/2"	5-1/2"
RO110-12SH	12"	5-9/16"



6" Wood Handle

Standard Shank - Philadelphia

No.	Blade	Heel Width
RO110-9	9"	5-1/8"
RO110-9-1/2	9-1/2"	5-3/16"
RO110-10	10"	5-1/4"
RO110-10-1/2	10-1/2"	5-3/8"
RO110-11	11"	5-7/16"
RO110-11-1/2	11-1/2"	5-1/2"
RO110-12	12"	5-9/16"

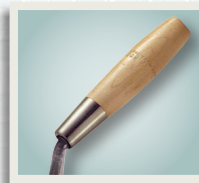

Leather Handle

Standard Shank - Philadelphia

No.	Blade	Heel Width
RO310-9	9"	5-1/8"
RO310-9-1/2	9-1/2"	5-3/16"
RO310-10	10"	5-1/4"
RO310-10-1/2	10-1/2"	5-3/8"
RO310-11	11"	5-7/16"
RO310-11-1/2	11-1/2"	5-1/2"
RO310-12	12"	5-9/16"

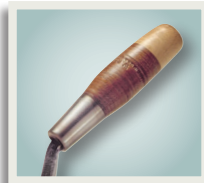

Plastic Handle

Standard Shank - Philadelphia

No.	Blade	Heel Width
RO1410-9	9"	5-1/8"
RO1410-9-1/2	9-1/2"	5-3/16"
RO1410-10	10"	5-1/4"
RO1410-10-1/2	10-1/2"	5-3/8"
RO1410-11	11"	5-7/16"
RO1410-11-1/2	11-1/2"	5-1/2"
RO1410-12	12"	5-9/16"

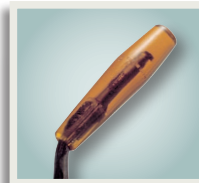

W. ROSE™ LIMBER BLADES

The same W. Rose™ quality with a more flexible blade. Available in our most popular blade patterns, sizes, and handles.

NARROW LONDON

Standard Shank, Limber Blade

ProForm® Soft Grip Handle

No.	Blade	Heel Width
RO116-10LSH	10"	4-1/2"
RO116-11LSH	11"	4-3/4"
RO116-11 1/2LSH	11-1/2"	4-7/8"
RO116-12LSH	12"	5"
RO116-13LSH	13"	5-3/8"

6" Wood Handle

No.	Blade	Heel Width
RO116-10L	10"	4-1/2"
RO116-11L	11"	4-3/4"
RO116-11 1/2L	11-1/2"	4-7/8"
RO116-12L	12"	5"
RO116-13L	13"	5-3/8"

Leather Handle

No.	Blade	Heel Width
RO316-10L	10"	4-1/2"
RO316-11L	11"	4-3/4"
RO316-11 1/2L	11-1/2"	4-7/8"
RO316-12L	12"	5"
RO316-13L	13"	5-3/8"

WIDE LONDON

Standard Shank, Limber Blade

ProForm® Soft Grip Handle

No.	Blade	Heel Width
RO112-10LSH	10"	5-1/2"
RO112-11LSH	11"	5-5/8"
RO112-11 1/2LSH	11-1/2"	5-3/4"
RO112-12LSH	12"	5-13/16"

6" Wood Handle

No.	Blade	Heel Width
RO112-10L	10"	5-1/2"
RO112-11L	11"	5-5/8"
RO112-11 1/2L	11-1/2"	5-3/4"
RO112-12L	12"	5-13/16"

Leather Handle

No.	Blade	Heel Width
RO312-10L	10"	5-1/2"
RO312-11L	11"	5-5/8"
RO312-11 1/2L	11-1/2"	5-3/4"
RO312-12L	12"	5-13/16"

PHILADELPHIA

Standard Shank, Limber Blade

ProForm® Soft Grip Handle

No.	Blade	Heel Width
RO110-10LSH	10"	5-1/4"
RO110-11LSH	11"	5-7/16"
RO110-11 1/2LSH	11-1/2"	5-1/2"
RO110-12LSH	12"	5-9/16"

6" Wood Handle

No.	Blade	Heel Width
RO110-10L	10"	5-1/4"
RO110-11L	11"	5-7/16"
RO110-11 1/2L	11-1/2"	5-1/2"
RO110-12L	12"	5-9/16"

Leather Handle

No.	Blade	Heel Width
RO310-10L	10"	5-1/4"
RO310-11L	11"	5-7/16"
RO310-11 1/2L	11-1/2"	5-1/2"
RO310-12L	12"	5-9/16"



WIDE HEEL BLADE PATTERN

Wide heel is useful when working on thick walls



ROUND HEEL BLADE PATTERN

Rounded heel has no corners to catch the mason's line



6" Wood Handle

Standard Shank - Wide Heel

No.	Blade	Heel Width
RO221-10	10"	6"
RO221-10-1/2	10-1/2"	6"
RO221-11	11"	6"
RO221-11-1/2	11-1/2"	6"
RO221-12	12"	6-1/8"



6" Wood Handle

Standard Shank - Round Heel

No.	Blade	Heel Width
RO113-10	10"	5"
RO113-10-1/2	10-1/2"	5-1/16"
RO113-11	11"	5-1/8"
RO113-11-1/2	11-1/2"	5-1/4"
RO113-12	12"	5-5/16"

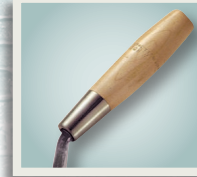

Leather Handle

Standard Shank - Wide Heel

No.	Blade	Heel Width
RO321-10	10"	6"
RO321-10-1/2	10-1/2"	6"
RO321-11	11"	6"
RO321-11-1/2	11-1/2"	6"
RO321-12	12"	6-1/8"



Leather Handle

Standard Shank - Round Heel

No.	Blade	Heel Width
RO313-10	10"	5"
RO313-10-1/2	10-1/2"	5-1/16"
RO313-11	11"	5-1/8"
RO313-11-1/2	11-1/2"	5-1/4"
RO313-12	12"	5-5/16"

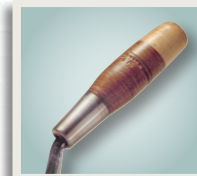

Plastic Handle

Standard Shank - Wide Heel

No.	Blade	Heel Width
RO1421-10	10"	6"
RO1421-10-1/2	10-1/2"	6"
RO1421-11	11"	6"
RO1421-11-1/2	11-1/2"	6"
RO1421-12	12"	6-1/8"



Plastic Handle

Standard Shank - Round Heel

No.	Blade	Heel Width
RO1413-10	10"	5"
RO1413-10-1/2	10-1/2"	5-1/16"
RO1413-11	11"	5-1/8"
RO1413-11-1/2	11-1/2"	5-1/4"
RO1413-12	12"	5-5/16"

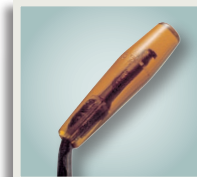

SPECIALTY TROWELS

SOLD IN
CARTONS OF 6

Blade and shank forged as one piece. Unique heat tempering process for hardness and strength. Hand polished for perfect flexibility.

Brick Weight Large Tang Pointing Trowel

Standard Shank

No.	Blade	Heel Width	Handle
RO50W	7"	3-3/8"	5" Wood
RO50L	7"	3-3/8"	5-1/2" Leather



RO50

Tile Trowel

Standard Shank

No.	Blade	Heel Width	Handle
RO75	7"	3-3/16"	5" Wood
RO55	7-1/2"	4-7/16"	5" Wood



RO75

RO55

Sewer Trowel

Standard Shank

No.	Blade	Heel Width	Handle
RO427-9 1/2	9-1/2"	6"	5" Wood



RO427

Pumpkin Seed Trowel

Standard Shank

No.	Blade	Heel Width	Handle
RO414-9	9"	4-3/4"	5" Wood



RO414-9

Mud Trowel

Standard Shank

No.	Blade	Heel Width	Handle
RO6302	7-1/2"	5-3/8"	6" Wood



RO6302

Buttering Trowel

Standard Shank

No.	Blade	Heel Width	Handle
RO74	7-1/2"	3-1/2"	5" Wood



RO74

Bucket Trowel

Standard Shank

No.	Blade	Heel Width	Handle
RO6301	8"	5-3/8"	6" Wood



RO6301

Gauging Trowel

Standard Shank

No.	Blade	Handle
RO118-9 1/2	9-1/2"	5" Wood
RO118-10	10"	5" Wood



RO118

POINTING & MARGIN TROWELS

Forged from a single piece of uniquely formulated steel. Long lasting with a comfortable weight and flexibility to the blade. Heat treatment produces a uniform hardness for scraping and digging. Pointing and Margin trowels are polished to perfection and come with smooth wood or comfortable leather handles.

Margin Trowels

Wood Handle

No.	Size
RO58-5	5" x 2"
RO58-6	6" x 2"
RO58-8	8" x 2"

Leather Handle

No.	Size
RO58-5L	5" x 2"
RO58-6L	6" x 2"
RO58-8L	8" x 2"



Pointing Trowels

Wood Handle

No.	Size
RO50-5	5" x 2-1/2"
RO50-6	6" x 2-3/4"
RO50-7	7" x 3-3/8"

Leather Handle

No.	Size
RO50-5L	5" x 2-1/2"
RO50-6L	6" x 2-3/4"
RO50-7L	7" x 3-3/8"



JOINTERS & SLED RUNNERS

Special heat tempering process for hardness and long wear. Hand polished steel for a smooth, perfect joint.



Sold in cartons of (12)

Convex Jointer

- Strong hot formed steel
- Most popular joint in the United States, creates inverted rounded impression in the mortar joint

No.	Size
RO5121-3/8x1/2	3/8" x 1/2"
RO5121-1/2x5/8	1/2" x 5/8"
RO5121-5/8x3/4	5/8" x 3/4"
RO5121-3/4x7/8	3/4" x 7/8"
RO5121-7/8x1	7/8" x 1"
RO5121-1x1-1/8	1" x 1-1/8"
RO5121-1-1/8x1-1/4	1-1/8" x 1-1/4"



Sold in cartons of (12)

Concave Jointer

- Creates a beaded protruding joint
- Very weathertight

No.	Size
RO5321-3/8x1/2	3/8" x 1/2"
RO5321-1/2x5/8	1/2" x 5/8"
RO5321-5/8x3/4	5/8" x 3/4"
RO5321-3/4x7/8	3/4" x 7/8"
RO5321-7/8x1	7/8" x 1"
RO5321-1x1-1/8	1" x 1-1/8"

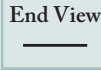

Sold in cartons of (12)

Flat Slicker

- Creates a smooth flush joint
- Prohibits moisture from entering the joint
- Great for tucking mortar into the joints.
- Ideal for exteriors

No.	Size
RO5211-1/4x3/8	1/4" x 3/8"
RO5211-3/8x1/2	3/8" x 1/2"
RO5211-1/2x5/8	1/2" x 5/8"
RO5211-5/8x3/4	5/8" x 3/4"
RO5211-3/4x7/8	3/4" x 7/8"
RO5211-7/8x1	7/8" x 1"
RO5211-1x1-1/8	1" x 1-1/8"
RO5211-1-1/8x1-1/4	1-1/8" x 1-1/4"



Sold in cartons of (12)

Grapevine Jointer

- Forged jointer creates shallow joints with an indented line, making it appear deeper
- Popular in colonial period brickwork and masonry restoration

No.	Size
RO5150	3/4" x 5/8"
RO5151	5/8" x 1/2"



Sold in cartons of (12)

Bullhorn Jointer

- The forged Bullhorn Jointer is great for touch-ups and compressing mortar

No.	Size (Large End)
RO5042-1/4	1/4"
RO5042-3/8	3/8"
RO5042-1/2	1/2"
RO5042-5/8	5/8"
RO5042-3/4	3/4"
RO5042-7/8	7/8"



Sold in cartons of (12)

"V" Jointer

- Creates a rustic appearance on rough and matte finish brick
- V shape creates a sense of depth in the joint

No.	Size
RO5121-5/8V	5/8" x 5/8"

Sled Runners

- Creates an inverted rounded impression in the mortar joint
- Quickly and efficiently make long, straight, and even joints
- Perfect for concrete block walls

A) Convex Loop Sled Runner

No.	Size	Length
RO5140-3/8	3/8"	17"
RO5140-1/2	1/2"	17"
RO5140-5/8	5/8"	17"
RO5140-3/4	3/4"	17"

B) Convex Mounting Sled Runner

No.	Size	Length
RO5141-1/2	1/2"	17-5/8"
RO5141-5/8	5/8"	17-5/8"
RO5141-3/4	3/4"	17-5/8"

Sold in cartons of (6)

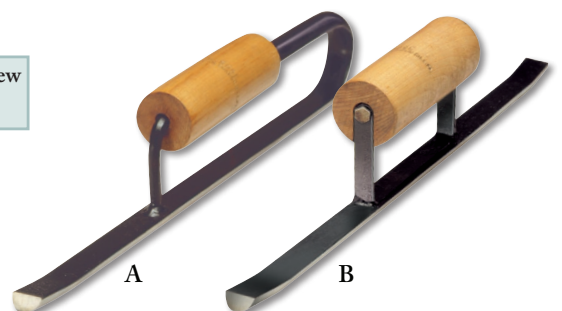

Professional Bonded Braided Nylon Line

Premium Quality

Super Tough - Will Not Sag

W. Rose™ professional quality, super tough, super strong. Bonded for better knot holding and abrasion resistance. 35% stronger than regular mason's line. 216 lb. test.

No.	Size	Color
RO685	685'	Yellow & Black
RO686	685'	Orange & Black
RO687	685'	"All American" Red, White, & Blue
RO688	685'	"Camo" Green, Gold, & Brown
RO689	685'	Orange, Black, & Gold

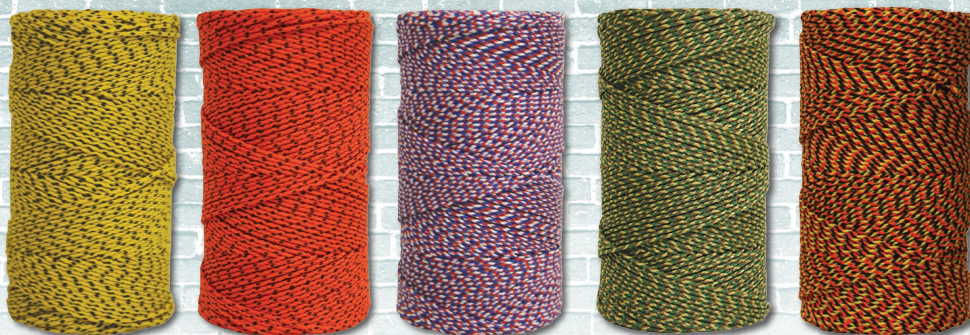

Yellow & Black Orange & Black "All American"
Red, White, & Blue "Camo" Green,
Gold, & Brown Orange, Black,
& Gold

Brick Hammer

Head is forged from highest quality tool steel available. 1-1/8" by 1-1/16" flat face provides a solid base to use with brick and tile chisels. Properly balanced for great leverage. Chisel end for breaking up brick and stone. Fitted with wood handle.

No.	Head Weight
RO3131-24	24 oz.



Carbide-Tipped Tile Hammer

Head is forged from highest quality tool steel available. Chisel end for breaking up brick and stone. Smooth wood handle is properly balanced for superior leverage and a comfortable grip. Available with a carbide tip for extra strength.

Carbide-Tipped

No.	Head Weight	Face Size
RO3122-5/8C	8 oz.	5/8"

Without Carbide

No.	Head Weight	Face Size
RO3122-5/8	8 oz.	5/8"



Line Pin

Precision forged, heavy-duty steel line pins. Hand polished. Sold individually.

No.	Description
RO2122	Individual Steel Line Pin



Sold Individually

Available in cartons of 12



Smith Levels

These handmade stainless steel bound walnut and maple laminated levels are used by the most discriminating craftsmen. Featuring metallic sealed yellow vials, handset in an unshrinkable compound. The exterior is sealed using raw linseed oil. Will not warp or delaminate. Each level features 6 vials for accurate leveling. Large hand holes make this level easy to maneuver on the job.

No.	Size
SMITH-18	18"
SMITH-24	24"
SMITH-36	36"
SMITH-42	42"
SMITH-48	48"

Smith Level Recondition Kit

Includes 6 replacement lenses, 6 lens ring holders and linseed oil.
No. SMITH-00



Ceremonial Trowels

Ideal for retirements, award presentations and other special occasions

No.	Description
RO316-10G	Gold
RO316-10C	Chrome



Sold in cartons of (6)

W. Rose™ Replacement Trowel Handles

ProForm® Handle - RO1000

Unique soft textured contoured 6" ProForm® soft grip handle. Tough, rugged and well-balanced, with hard urethane endcap for tamping.
(US Patent #D508638)

6" Wood Handle - RO100

5" Wood Handle - RO400

Smooth comfortable strong second-growth hardwood handle fitted with steel ferrule.

Leather Handle - RO300

5-1/2" seasoned wood handle wrapped with genuine leather to provide a smooth comfortable grip. Fitted with steel ferrule. Helps absorb moisture from sweat.

Plastic Handle - RO1400

Clear amber colored 5-1/4" plastic handle. Tough and rugged handle will not mushroom from tamping bricks or concrete blocks.

Margin Trowels

- One-piece forged for strength and flexibility
- Tempered, ground and polished for perfect balance

Wood Handle

No.	Blade Size
GG431	5"x1-1/2"
GG432	5"x2"
GG434	6"x2"
GG433	8"x2"



ProForm® Handle

No.	Blade Size
GG431PF	5"x1-1/2"
GG432PF	5"x2"
GG434PF	6"x2"
GG433PF	8"x2"



Pointing Trowels

- One-piece forged for strength and flexibility
- Tempered, ground and polished for perfect balance

Wood Handle

No.	Blade Size
GG420	4"x2"
GG421	4-1/2"x2-1/4"
GG424	5"x2-1/2"
GG422	5-1/2"x2-1/2"
GG427	6"x2-3/4"
GG423	7"x3"



ProForm® Handle

No.	Blade Size
GG420PF	4"x2"
GG421PF	4-1/2"x2-1/4"
GG424PF	5"x2-1/2"
GG422PF	5-1/2"x2-1/2"
GG427PF	6"x2-3/4"
GG423PF	7"x3"



Caulking Trowels

- One-piece forged for strength and flexibility
- Tempered, ground and polished for perfect balance
- Ideal for tuckpointing

Wood Handle

No.	Blade Size
BL761	6-5/8"x3/16"
BL762	6-5/8"x1/4"
BL763	6-5/8"x3/8"
BL764	6-5/8"x1/2"
BL765	6-5/8"x5/8"
BL766	6-5/8"x3/4"
BL767	6-5/8"x7/8"
BL768	6-5/8"x1"

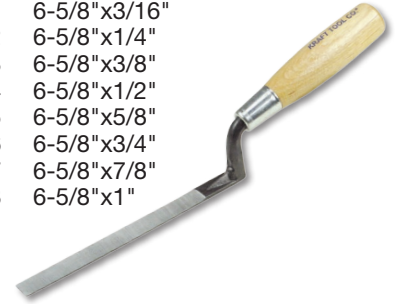

ProForm® Handle

No.	Blade Size
BL761PF	6-5/8"x3/16"
BL762PF	6-5/8"x1/4"
BL763PF	6-5/8"x3/8"
BL764PF	6-5/8"x1/2"
BL765PF	6-5/8"x5/8"
BL766PF	6-5/8"x3/4"
BL767PF	6-5/8"x7/8"
BL768PF	6-5/8"x1"



Margin / Pointing Trowel Leather Pouch

Convenient leather pouch easily snaps around belt. Fits Pointing and Margin Trowels (6" or smaller).

No. AR100

See page 133 for Archaeology Tools.



Aluminum Solid Wheel Joint Raker

Solid steel wheels bridge the joint while a 2" adjustable nail rakes joints. The aluminum handle can also be used for tooling joints.

No. BL209



Skate Wheel Joint Raker

Masons love this big wheeled joint raker. Wheels are 1-3/4" in diameter, mounted 2-1/4" apart. Overall width is 3-5/8". Has 8-1/2" aluminum handle that is squared off at the end to rod joints. Hardened nail is adjusted for depth.

No. BL210



Finger Tape

Protect fingers from abrasions and cuts by wrapping individual fingers with cloth finger tape. 165' per roll.

No. Size
BL400 1" x 165'

Professional Nylon Tool Bag

Double layer of nylon with heavy reinforced bottom makes this a perfect bag for the professional. Extra large zippered opening for tools and supplies. Comes with 14 inside pockets, 6 outside pockets, and heavy-duty handles and shoulder strap.

No. Size
WL103* 24"x10-1/2"x13-1/2"



Professional Leather Bottom Bag

Heavy-duty, lightweight leather bottom canvas bag comes with tough nylon support handles. A masonite bottom board holds the bag in shape and provides waterproofing.

No. Size
WL224 24"



Deluxe Canvas Tool Bags

An expertly made bag, deep and roomy, built around a 12-gauge steel hinged frame. Leather handles, buckles and canvas are riveted into the frame. Lock-stitched sewing assures long life. A masonite bottom board provides waterproofing. 9"x11" inside pocket.

No. Size
WL020 14"x20"
WL024 14"x24"



Professional Quality Kraft Tool Brick Trowels

- One-piece forging made from the highest grade trowel steel
- Taper ground for flexibility
- Precision balanced
- Fitted with 6" hardwood handle



Narrow London

Narrow heel is good for general masonry and brick projects.

No.	Blade Size
BL703	10"x4-1/4"
BL705	11"x4-5/8"
BL707	12"x5"



Wide London

Wide heel holds more mortar for block and stonework.

No.	Blade Size
BL723	10"x5-1/2"
BL729	11"x5-1/2"
BL772	12"x6"



Philadelphia

Square heel holds the most mortar, popular with block work.

No.	Blade Size
BL750	10"x5"
BL752	11"x5-1/2"
BL754	12"x5-5/8"

Replacement Handle

No.	Size
BL101	6" Hardwood

Rubber Tip for Brick Trowel Handle

No.
BL104



PROFESSIONAL MASONRY TROWELS

Kraft Tool Brick and Specialty Trowels

- *One-piece forged for strength and flexibility*
- *Made of high grade trowel steel*
- *Tempered, ground and polished for perfect balance*
- *Taper ground blades for flexibility*

Buttering Trowel



Wood Handle

No.	Blade Length	Heel Width
GG441	7"	4-5/8"

ProForm® Handle

No.	Blade Length	Heel Width
GG441PF	7"	4-5/8"

Cross Joint Trowel



Wood Handle

No.	Blade Length	Heel Width
GG445	5"	1-3/4"

ProForm® Handle

No.	Blade Length	Heel Width
GG445PF	5"	1-3/4"

Gauging Trowel



Wood Handle

No.	Blade Length	Heel Width
GG443	7"	3-1/4"

ProForm® Handle

No.	Blade Length	Heel Width
GG443PF	7"	3-1/4"

Duck Bill Trowel



Wood Handle

No.	Blade Length	Heel Width
GG444	10"	2"

ProForm® Handle

No.	Blade Length	Heel Width
GG444PF	10"	2"

Bucket Trowel

End of blade is cut off diagonally for easy scraping or mixing in buckets or mortar boxes.

No.	Blade Length
BL700	6"



Hi-Craft®
Masonry Tools
Page 97



JOINTERS & SLED RUNNERS



"The Original"

-Hubbard Jointers-

The Hubbard Jointer was designed by a bricklayer in the business for 60 years. The cast aluminum handle gives more knuckle clearance. Wear is distributed by revolving the tubular steel blade. Jointer comes assembled with one 1/2" blade and one 5/8" blade. One 3/4" blade and one 7/8" blade is also included in set. Replaceable steel blades available. Keep the handle - replace the blades. Overall length 8-1/2".

New and improved retail packaging for jointer and replacement blades.



No.	Description
BL280	Jointer with 1/2", 5/8", 3/4", 7/8" Blades
BL281	1/2" (13mm) Replacement Blade
BL282	5/8" (16mm) Replacement Blade
BL283	3/4" (19mm) Replacement Blade
BL284	7/8" (22mm) Replacement Blade

MASONRY Barbell Jointer®



- 7-1/2" Long, high quality tool steel
- Package of 2

"Half Round Convex" Sled Runners



- The best tool you can get for making round sunken concave or rodded masonry joints
- High quality steel blade
- 14" blade (shown) turned up on one end only and 20" blade turned up on both ends

Wood Handle No.	ProForm® Handle No.	Size
BL215	BL215PF	14"x1/2"
BL216	BL216PF	14"x5/8"
BL217	BL217PF	14"x3/4"
BL229	BL229PF	20"x1/2"
BL226	BL226PF	20"x5/8"
BL227	BL227PF	20"x3/4"



Masonry Barbell Jointer®

Faster jointing

Even wear, Longer life

- Round head joints in all directions
- Eliminates changing hand or wrist positions
- Keeps knuckles away from wall
- When using fast setting mortar, it allows you to apply more pressure with less effort
- 2 jointers per package

No. BL390

"V" Sled Runners



- High quality steel blade
- Very handy in block construction
- Makes perfect horizontal "V" joints
- 14" blade (shown) turned up on one end only and 20" blade turned up on both ends

Wood Handle No.	ProForm® Handle No.	Size
BL214	BL214PF	14"x3/4"
BL220	BL220PF	20"x3/4"

Hubbard Sled Runners

"The Original"

- Hubbard sled runner operates the same way as the jointer. Keep the handle, replace the blade
- The ideal tool for making half-round sunken joints
- Turning the blade during use helps evenly distribute wear
- Cast aluminum blade holder with wood handle
- Includes a 3/4" diameter blade made of case-hardened steel



No.	Description
BL286	14" Sled Runner with 3/4" Blade
BL285	5/8" Replacement Blade
BL287	3/4" Replacement Blade
BL288	7/8" Replacement Blade

Grapevine Jointer

Carefully forged from high carbon steel, this jointer with handle is especially convenient when the job calls for this special colonial-style joint. Bit is 1/8" wide on center of blade. 5"x1/2" blade. Curved up end for moving thorough mortar.

Wood
No. BL401
ProForm®
No. BL401PF



JOINTERS

Brick Jointers

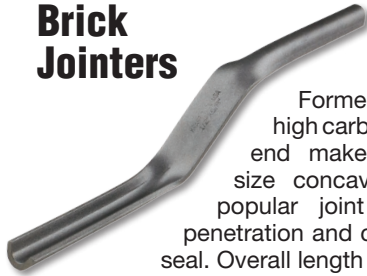

Formed from quality high carbon steel. Each end makes a different size concave joint. This popular joint resists rain penetration and creates a tight seal. Overall length 10-1/2".

No.	Size
BL260	3/8"x1/2"
BL261	1/2"x5/8"
BL262	5/8"x3/4"
BL264	3/4"x7/8"
BL265	7/8"x1"

Variable Convex Jointer Extra Hard



Extra hard tempered steel jointer for tile, brick and mortar joints. Produces smooth half round sunken joints. Jointer tapers from 5/8" to 7/8" on curvature. Legs measure 3-1/2" and 4-1/4" long. Easy to handle tool adjusts to various joint widths.
No. BL660

Double Blade Slicker

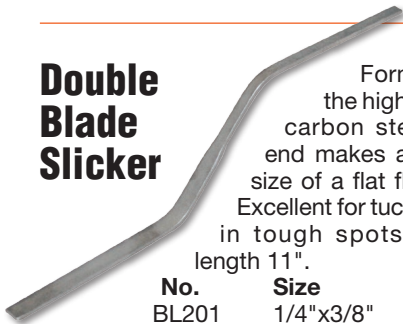

Formed from the highest grade carbon steel. Each end makes a different size of a flat flush joint. Excellent for tuck pointing in tough spots. Overall length 11".

No.	Size
BL201	1/4"x3/8"
BL202	1/2"x5/8"

Brick and Stone Marker

A unique cutting tool carves out joints when using imitation brick, stone and veneering. The lightweight tool cuts out mortar joints. Tough, 1/2" wide heat-treated blade is designed to allow the mortar to move out of the joint. The 8" aluminum handle is easy to grasp. Overall length is 10".

No.	Description
BL207	Cutter with Blade
BL208	Extra Blade

Diamond "V" Head Jointers



Works well for striking head joints. Forged from carbon steel. Overall length 9".

No.	Size
BL290	1/2"
BL291	5/8"

Plexiglass Jointers



Use this plexiglass jointer on white mortar. Will not discolor or leave black marks. A popular tool used with glass blocks. Overall length 11-1/4".

No.	Size
BL273	1/4"
BL274	3/8"
BL276	1/2"
BL277	5/8"
BL278	3/4"

Stone and Brick Bearer (Grapevine)



Steel blade produces 5/16" raised grapevine joints for a popular Southern look. Double end. Overall length 11-1/2".

No.	Size
BL405	5/16"

Combination Raker-Jointer



Steel raker-jointer is used on rough materials such as adobe brick, split stone, and split block. It has a 3/4" convex jointer on one end, and a 5/16" raker blade at the other end. Overall length 10".
No. BL205

"S" Jointers Ultra Hard



U.S. Patent #4,879,780

Heavyweight Convex Jointers



Forged steel with one large end, tapered at the other to produce half round sunken joints.

No.	Size
BL270	9-1/2"x1/2"
BL271	9-1/2"x5/8"
BL272	9-1/2"x3/4"

Double End Grapevine Jointers



Forged from high quality tool steel. Creates a thin line in the middle of the joint. Popular in colonial period brickwork and masonry restoration. Overall length is 8".

No.	Width	Center Groove
BL402	1/2"x5/8"	1/8"
BL403	5/8"x3/4"	1/8"

Lightweight Concave Stone Benders



Steel jointer produces raised half round beaded joints. A formal looking joint popular on interiors. Creates 2 sizes of beads. Overall length 10-1/2".

No.	Size
BL140	3/8"x1/2"
BL141	5/8"x3/4"

Low Cost Joint Raker



Lets you work where you can't with a wheeled jointer. The 5/16" steel joint raker is offset to throw out mortar as you rake. A 5/16" and 3/8" tab at the ends help you rake the corners. Overall length 8".
No. BL103

The patented "S" curve allows you to approach or maintain different pitch angles while jointing the mortar. Long-wearing hard steel. Overall length 9-1/4".

No.	Size
BL160	3/8"x1/2"
BL161	1/2"x5/8"
BL162	5/8"x3/4"
BL164	3/4"x7/8"
BL165	7/8"x1"